

Seat and seatbelt accommodation in fire apparatus: Anthropometric aspects



Hongwei Hsiao^{a,*}, Jennifer Whitestone^b, Michael Wilbur^c, J. Roger Lackore^d,
J. Gordon Routley^e

^a National Institute for Occupational Safety and Health (NIOSH), Morgantown, WV, USA

^b Total Contact Inc., Germantown, OH, USA

^c Emergency Vehicle Response, Otisville, NY, USA

^d Fire Apparatus Manufacturers Association, Lynnfield, MA, USA

^e International Association of Fire Chiefs, Fairfax, VA, USA

ARTICLE INFO

Article history:

Received 16 September 2014

Accepted 11 April 2015

Available online xxx

Keywords:

Firefighter

Seatbelt

Anthropometry

ABSTRACT

This study developed anthropometric information on U.S. firefighters to guide fire-apparatus seat and seatbelt designs and future standards development. A stratified sample of 863 male and 88 female firefighters across the U.S. participated in the study. The study results suggested 498 mm in width, 404 mm in depth, and 365–476 mm in height for seat pans; 429–522 mm in width and 542 mm in height for seat back; 871 mm in height for head support; a seat space of 733 mm at shoulder and 678 mm at hip; and a knee/leg clearance of 909 mm in fire truck cab. Also, 1520 mm of lap belt web effective length and 2828 mm of lap-and-shoulder belt web effective length were suggested. These data for fire-truck seats and seatbelts provide a foundation for fire apparatus manufacturers and standards committees to improve firefighter seat designs and seatbelt usage compliance.

Published by Elsevier Ltd.

1. Introduction

1.1. Seatbelt use influences firefighter safety

There are approximately 1.1 million firefighters in the United States (Karter and Stein, 2011) and vehicle-related incidents are the second leading cause of firefighter line-of-duty fatalities (Karter and Molis, 2013). During the 10-year period from 1998 to 2007, 148 firefighters were killed in 133 road vehicle incidents (Fahy, 2008). Also, in 2011 alone, 14,850 fire department emergency vehicle collisions occurred, resulting in 970 firefighter injuries, while fire departments were delivering emergency services (Karter and Molis, 2012). Lack of seatbelt use was identified as a significant contributing factor to these deaths and injuries. Of the 406 firefighter deaths while responding to fires and returning to stations during 1977–2006, seventy-six percent were not belted (Routley, 2006).

While seatbelt noncompliance is sometimes attributed to departmental culture or inherent risk-taking personalities of firefighters (Siarnicki, 2011), it has been demonstrated that some firefighters are not physically able to easily buckle their seatbelt when encumbered with turnout gear and firefighting equipment. A NIOSH (National Institute for Occupational Safety and Health) Fire Fighter Fatality Investigation and Prevention Program review report noted that a quarter of fire departments indicated that their firefighters were not able to fit comfortably in their seatbelts while wearing turnout gear in emergency vehicles (Peterson et al., 2009). Also, unpublished data from this study found that 38% of female and 48% of male firefighters had problems with seatbelt use in their fire trucks (NIOSH, 2012).

Adequate seatbelt use and seat configuration have proven efficacy in reducing the likelihood of injury in fire-truck collisions (Campbell, 1999; NIOSH, 2005). The difficulty experienced by some firefighters in fastening their seatbelts was due to trade-offs in the design of both the seat and seatbelt systems. Many of these firefighters experienced difficulty in reaching their seatbelts because seat spacing was too narrow and confining. For others, the belt length was too short and occupants were unable to buckle their belt

* Corresponding author. National Institute for Occupational Safety and Health, 1095 Willowdale Road, Morgantown, WV 26505, USA.

E-mail address: hxh4@cdc.gov (H. Hsiao).

without first removing their jacket or their personal protective equipment.

1.2. History of fire apparatus seat and seatbelt standards

Fire truck seat and seatbelt designs are addressed in the National Fire Protection Association (NFPA) 1901 Standard for Automotive Fire Apparatus and 1906 Standard for Wildland Fire Apparatus. In 1991, NFPA apparatus standards specified that all firefighters riding on an apparatus must be inside a completely enclosed cab equipped with an approved seatbelt for each occupant (Peters, 2014; NFPA, 2008). A sign stating “Occupants must be seated and belted when apparatus is in motion” needed to be visible from each seating position. Also at that time the standards established seat unit space of 560 mm at the shoulder level, seat pan width of 460 mm at hip level, and seat pan depth of 380 mm.

Beginning in 1999, the NFPA added further requirements for seatbelt design, stating that each crew riding position must be provided with a seatbelt, that forward-facing seats adjacent to a side wall must be provided with a lap-and-shoulder belt, and that the seatbelt must be “designed to accommodate a person with and without heavy clothing” (NFPA, 2003). Fire apparatus manufactured during this period were not required to meet any special seatbelt length other than what was mandated by the Federal Motor Vehicle Safety Standards (FMVSS 209; U.S. Department of Transportation, 2013a) which stated that the seat belt adjustment must accommodate a 5th percentile adult female (46.3 kg weight and 599 mm waist circumference) up to a 95th percentile adult male (97.5 kg weight and 1080 mm waist circumference). These percentile values were based on the military MIL-STD-1472 data and standards (U.S. Department of Defense, 2012).

While these seat and seatbelt specifications for fire apparatus did evolve to include some consideration for the bulk and encumbrance created by firefighting clothing, there were no specific dimensional values to guide the seat, seatbelt, or apparatus manufacturer. In 2006, the National Fallen Firefighters Foundation (NFFF), International Association of Fire Chiefs (IAFC), International Association of Fire Fighters (IAFF), Safety Task Force of the NFPA 1901 Fire Apparatus Standards Committee, and Fire Apparatus Manufacturers' Association (FAMA) jointly advocated for an anthropometric study of U.S. firefighters to update dimensional specifications on fire apparatus seats and seatbelts. NIOSH began a research review process of the subject in 2007 and initiated the national firefighter anthropometry study in 2008 (Hsiao, 2008).

The updated 2009 edition NFPA1901 Standard for Automotive Fire Apparatus (NFPA, 2008) retained the same specifications for seats dimensions as those that appear in the 2003 edition (NFPA, 2003). The 2009 standard adopted study data available from a pilot study of firefighter anthropometry (NIST, 2008) and a white paper from fire apparatus manufacturers on firefighter anthropometry (FAMA, 2007) for its seatbelt specification development. The 2009 standard also adopted a sizing procedure for the development of seatbelt specifications that was proposed in 2007 for this current project (Hsiao, 2008). The 2009 edition specified that seatbelt web length shall be a minimum of 2800 mm for Type II belts (pelvic and upper torso restraint) and a minimum of 1525 mm for Type I belts (pelvic restraint).

1.3. Relation to other standards

Firefighters wear equipment and clothing that weigh, on the average, 11.9 kg for men and 10.5 kg for women (Hsiao et al., 2014). The seats and seatbelt systems designed for general purpose would not accommodate firefighters well. In addition, seats and seatbelt systems designed and sized for the military (i.e., MIL-STD-1472)

and for the general population (i.e., FMVSS) may not provide the same level of fit for firefighters because the designs do not reflect the greater body size exhibited by the firefighter population (Hsiao et al., 2002). For instance, the 5th percentile female firefighter weighs 56.6 kg with a waist circumference of 732 mm. By comparison, according to MIL-STD-1472 and FMVSS, the 5th percentile female weighs 46.3 kg and has a waist circumference of 599 mm. Similarly, the 95th percentile male firefighter weighs 120 kg with a waist circumference of 1165 mm. By contrast, according to MIL-STD-1472 and FMVSS, the 95th percentile male weighs 97.5 kg with a waist circumference of 1080 mm (Hsiao et al., 2014). Now that the NIOSH national firefighter anthropometry study has been completed, there are sufficient data to systematically evaluate the current design specifications of seats and seatbelts.

2. Objectives

This paper evaluated current NFPA specifications of fire-apparatus seats and seatbelts using data obtained through the NIOSH national firefighter anthropometry study and proposed modifications to the specifications. Specifically, this study assessed the following NFPA seat and seatbelt standards and provided data which standards developers can use to evaluate seating and seatbelt minimum standards to accommodate the current U.S. firefighter population:

The NFPA 1901 standard specifies a minimum of 460 mm in seat pan width and 380 mm in seat cushion depth (Fig. 1a), a minimum of 460 mm in width for seat backrest at the base, a minimum of 460 mm vertical backrest support, and a minimum width of 560 mm at the shoulder level as a seat unit space (Fig. 1b).

The NFPA 1901 standard requires Type II (3-point) belts (Fig. 1c) for forward-facing outboard seating positions; Type I belts (lap belts) were acceptable for all other seats, including tiller cabs. The standard specifies that seatbelt web length shall be a minimum of 2800 mm for Type II belts and a minimum of 1525 mm for Type I belts.

The NFPA 1901 standard defines the minimum seat head height of 940 mm for suspension-style seats and 889 mm for non-suspension-style seats; both were measured with the seat height adjustment in its lowest position. These dimensions are measured from the seat H-Point (or Seating Reference Point) which is an imaginary position representing the human pelvis joint. This position is approximately 97.6 mm above the depressed seat cushion and 134.3 mm ahead of the seat back (SAE, 1995) or 75 mm up from the non-depressed seat cushion surface and 130 mm ahead of the seat back (NFPA, 2008) (Fig. 2a).

This study provided updated firefighter anthropometry data to verify the seat dimensions and seatbelt lengths specified above. In addition, this study developed specifications for seat pan height (Fig. 2a), head support height (Fig. 2a), seat spacing at hip level (Fig. 2b), and knee clearance (seat fore-aft space) (Fig. 2c).

3. Methods

3.1. Critical anthropometric measurements associated with seat and seatbelt specifications

Fourteen dimensions relevant to the design of seats and seatbelts were measured in this study. The definitions of these dimensions are listed in Appendix A and the inferences of these dimensions are summarized in Table 1. Seven of the 14 measurements were collected while the participants were wearing their personal turnout gear, including personal selection of tools stored in their pockets, in an erect seated posture. The remaining seven measurements were collected when the participants were in fitted

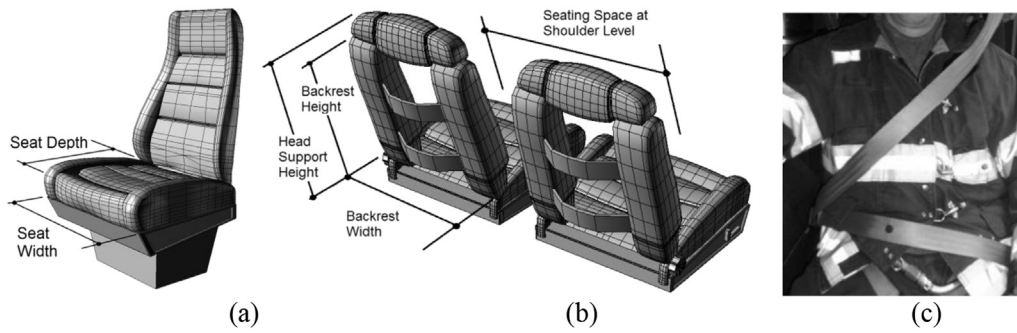

Fig. 1. Seat and seatbelt configurations: (a) seat pan width and depth; (b) backrest width, backrest height, head support height, and unit seating space; and (c) three-point seatbelt (Type II belt), including the shoulder strap and lap belt; the lap belt alone is a Type I belt.

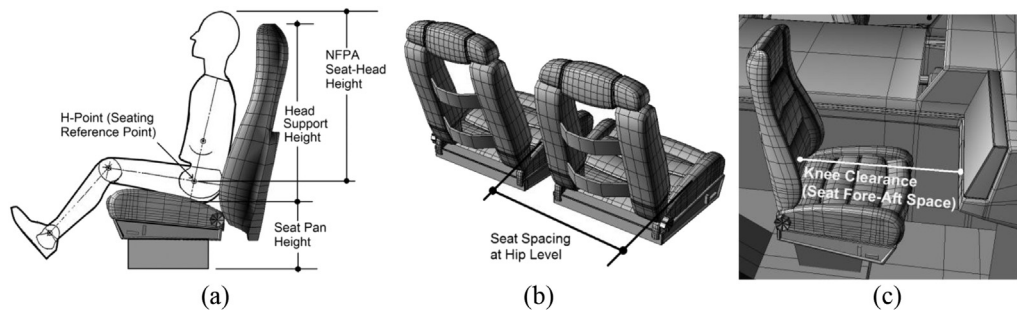

Fig. 2. Seat space configurations: (a) seat H-Point (or Seating Reference Point), seat pan height, head support height, and NFPA seat-head height; (b) seat spacing at hip level; and (c) knee clearance (seat fore-aft space).

shorts, and also in an erect seated posture. Contrasting with other vehicle seat and seatbelt design applications, the seven in-gear anthropometric measurements were collected because firefighters are frequently seated while in gear. The seven measurements without gear were mostly sitting height-related dimensions (e.g., popliteal height and nuchal height); they were used for height-related designs which are not affected by clothing and for comparisons with existing literature on vehicle seat dimensions. Two measurements (bideltoid breadth and hip breadth) were collected both in gear and without gear for different applications; the measurements in gear were to specify spacing requirements between seats in a row at shoulder and hip levels, respectively, while the measurements without gear were for defining backrest width and seat pan width.

3.2. Participants

A stratified sample of 863 male firefighters (3-age × 3-race/ethnicity combinations) and 88 female firefighters (3-age groups) from four geographic locations (Rockville, MD; Phoenix, AZ; Philadelphia, PA; and Fort Worth, TX) participated in the study (Table 2). As part of the national firefighter anthropometry survey (Hsiao et al., 2014), firefighters' body dimensions relevant to seat and seatbelt configurations were collected.

The sampling plan of 951 participants was based on a statistical power estimation for between-gender and between-age assessments of the proposed dimensions representing the 1,136,650 firefighters from the U.S. Fire Department Profile Through 2005 (Karter, 2006). The Fire Department Profile contained the best

Table 1
Critical anthropometric measurements associated with seat and seatbelt specifications.

Dimensions (seated)	Application	Accommodation
Acromion breadth, no gear	Seat backrest minimum width at shoulder level section	95th (Men)
Acromion height, no gear	Seat backrest height	5th (Women)
Bi-deltoid breadth in gear	Seat space at shoulder level for seats in a row	95th (Men)
Bi-deltoid breadth, no gear	Seat backrest maximum width at shoulder level	95th (Men)
Bi-trochanter curve length in gear	Lap belt length	99.9th (Men)
Bi-trochanter-acromion length in gear	Shoulder belt and lap belt total length	99.9th (Men)
Buttock-popliteal length in gear	Seat pan depth	5th (Women)
Buttock-shoe tip length in gear	Knee clearance/Seat fore-aft space (project to floor level)	95th (Men)
Hip breadth in gear	Seat space at hip level for seats in a row	95th (Men)
Hip breadth, no gear	Seat pan width	95th (Men)
Nuchal height, no gear	Minimum head support/restraint height	99th (Men)
Popliteal height, no gear	Seat pan height	5th Women to 95th Men
Sitting height, no gear ^a	Ceiling height from seat pan surface	95th (Men)
Waist breadth in gear ^b	Seat backrest width at the base section	95th (Men)

^a Measurements involving seated height are from the seat cushion plane, not the H-point (seat reference point).

^b Waist breadth without gear would be the needed dimension to define the seat backrest minimum width at the base section. It would be in line with the acromion width without gear for seat backrest minimum width at the upper section. However, fire truck seat backrests are typically straight from bottom to top, especially when a room for self-contained breathing apparatus (SCBA) is included. The waist breadth in gear was measured to provide additional information for seat backrest width determination.

Table 2
The stratified sample (3-age × 3-race/ethnicity × 2-gender combinations) in the study.

Data collection site	Age												Total
	Male						Female						
	White			Black			Hispanic/Other						
	18–32	33–44	45–65	18–32	33–44	45–65	18–32	33–44	45–65	18–32	33–44	45–65	
Phoenix, AZ	46	47	43	3	3	3	13	17	13	7	7	8	210
Philadelphia, PA	49	55	52	6	5	11	4	5	2	7	8	5	209
Rockville, MD	63	62	63	10	8	9	8	9	6	8	13	5	264
Fort Worth, TX	55	72	59	7	14	14	9	9	9	5	10	5	268
Total measured	213	236	217	26	30	37	34	40	30	27	38	23	951
Statistical weights	1.09813	1.02811	1.09182	1.05637	0.94971	0.75191	0.63409	0.55910	0.72793	1.06852	0.78756	1.27056	

available and most updated information at the study planning stage in 2007. Department of Labor Household Data Survey for the years 2000–2004 indicated a distribution of 4.2% female firefighters and 95.8% male firefighters (U.S. DOL, 2006). In the national firefighter anthropometry survey, an over-sampling (2.2 times) of female firefighters was necessary in order to address some fire apparatus design issues that are critical to females, such as seat height and backrest height.

The data collection stations consisted of a briefing table, a changing area, and a space with sufficient lighting for measurements. Participants were approached through firefighter associations and leaders of regional fire stations at four data collection sites as identified in Table 2. Data collection was performed during 2009–2012 in the order of Rockville, MD; Phoenix, AZ; Philadelphia, PA; and Fort Worth, TX. The number of participants in each region was assigned based on the size of the population in that region in the 2000 U.S. Census (U.S. Census Bureau, 2001) with an assumption that the number of firefighters is proportional to the size of the population they serve. The detailed sampling plan, accounting for geographic density of racial/ethnic distributions, was presented in Hsiao et al. (2014).

Statistical weights for the participants were calculated and applied in data analyses to ensure that the sample represents the firefighter population in age and race/ethnicity composition for men and age distribution for women (Table 2). The weights are calculated as the relative frequency of a given cell in the firefighter population, divided by the relative frequency of the same cell in the survey sample (ISO, 2008). It can be expressed as

$$\text{Weight}_{i,j} = \frac{[N_{i,j}/(N_{1,1} + N_{1,2} + \dots + N_{i,j})]}{[n_{i,j}/(n_{1,1} + n_{1,2} + \dots + n_{i,j})]},$$

where N is the count from the age/race cell in the firefighter population, n is the count from the age/race cell in the survey sample, i

is the subscript for the age group, and j is the subscript for the racial group. Samples were weighted across three age groups (18–32, 33–44, and 45–65) for both men and women as well as three race/ethnicity groups (Non-Hispanic White, Non-Hispanic Black, and Hispanics & Others) for men. The detailed weighting process was presented in Hsiao et al. (2014).

3.3. Procedures

Upon arrival at the field laboratory at a fire station, the firefighters were greeted and given a brief overview of the study. Before data collection, participants signed a consent form and filled out a questionnaire relating to demographic information and experience with fire apparatus. The participants changed from street clothes into form-fitting shorts for the male firefighters or form-fitting shorts and a sports bra for the female firefighters. The firefighters were seated erect on a bench with a vertical backrest. An adjustable block was placed under the firefighters' feet so that their knees were at a 90-degree angle. Anatomical landmarks were identified and marked on the subject prior to measurement (Fig. 3a). Seven dimensions were measured as part of a national firefighter anthropometry survey (Hsiao et al., 2014). Of these dimensions, body breadths were acquired using sliding calipers (Fig. 3b) and vertical heights were registered using a FARO digitizing arm (Fig. 3c). Experienced data collection crews with knowledge and skill in meeting the allowable observer error as specified by Gordon et al. (1989) were hired to perform data collection. They practiced measurements each week during the data collection period.

Next, the firefighters were asked to go to the changing area and change back into the clothes that they normally wear under their bunker gear. They were then asked to don their bunker gear. The firefighters were requested to keep all the equipment they usually carry in their pockets (e.g., hand tools, gloves, rope) and to keep any

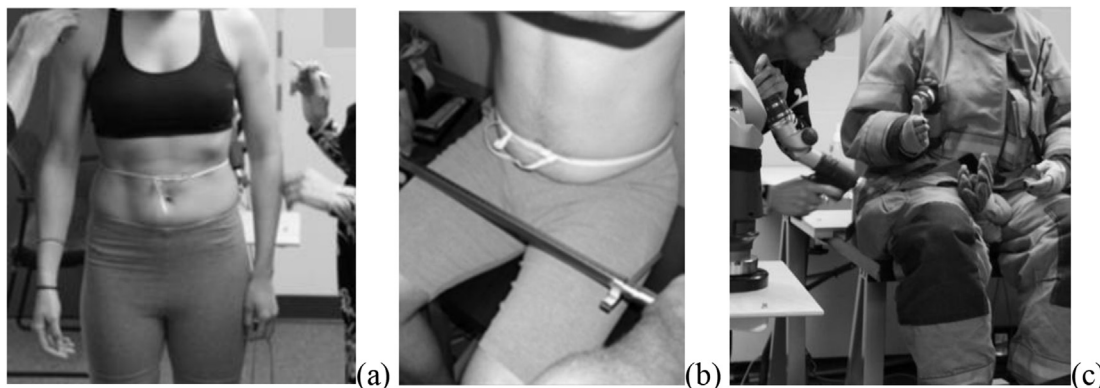

Fig. 3. The data collection procedure included three components: (a) anatomical landmarks were first identified; (b) anthropometric measurements without gear were then performed (also shown is the use of a sliding caliper); and lastly (c) in-gear anthropometric measurements were collected (also shown is the use of a FARO digitizing arm).

equipment attached to their bunker gear in the position that it usually occupies. The firefighters were then positioned back on the bench for the seven seated measurements in gear (Fig. 3c). The same FARO digitizing arm and sliding calipers used during the no-gear section were employed to measure the vertical heights and body breadths, respectively. Measurements of body depths in gear were obtained using an anthropometer. In addition, a tape measure was used to gather the left-trochanter to right-trochanter curve length and the overall curve length of left-trochanter to right-trochanter to left-acromion.

4. Results

4.1. Summary statistics for the measured dimensions

Statistical analyses on the 14 body measurements were performed for the arithmetic mean, standard error of the mean, standard deviation, the 5th percentile value, and the 95th percentile value for each measurement. These data (Table 3) were calculated based on the weighted samples exhibited in Table 2. There were a few missing data points for two variables (bi-deltoid breadth – no gear and hip breadth – no gear). Pairwise deletion of missing data was employed, which meant that all valid data points were included in the analyses for the respective variables. At the beginning of data collection (as part of the national firefighter anthropometry survey), in-gear buttock-popliteal length measurement was replaced with in-gear buttock-knee length measurement to define more precisely space requirements between front and back seats. This resulted in no directly-measured data on buttock-popliteal length in gear for the seat pan depth application. In this report, buttock-popliteal length data (in gear) were adopted from a pilot study of 120 firefighters

(84 men and 36 women) conducted by the same research team in 2008.

4.2. Application of the results

4.2.1. Seat pan width

The minimum seat pan width is constrained by the hip breadth (without gear) of the larger male or female segment (the 95th percentile value) of firefighters, whichever is larger. Data from Table 3 indicate that the value would be 498 mm. The selected criterion to accommodate 95% of male firefighters, rather than 99%, represents a tradeoff between the comfort of occupants with broad buttocks and the practicality of designing seats that do not exceed the space constraints faced by manufacturers of fire apparatus.

4.2.2. Seat pan depth and height

The seat pan depth (also referred in the literature as cushion length) can be determined based on the 5th percentile value for buttock-popliteal length of female firefighters in gear, which is 404 mm (Table 3). The seat pan height (adjustable) can be defined based on the 5th percentile value for popliteal height of female firefighters without gear to the 95th percentile value of popliteal height of male firefighters without gear, which would be 370 mm–481 mm. Taking off 30 mm for comfort (Bhise, 2012) and adding 25 mm height to account for shoe height (Das and Grady, 1983), the seat pan height would be 365–476 mm. For non adjustable seats, the 34th percentile value of popliteal height of male and female firefighters combined without gear would be appropriate; the height is slightly lower than the 50th percentile value to lessen the potential intrusiveness of seat at the popliteal areas. The value would be $\text{mean} - Z_{0.34} \times \text{standard deviation} = 438 - 0.415 \times 25.6 = 427 \text{ mm}$, which was calculated

Table 3
Summary statistics of firefighter anthropometry (weighted; Unit: mm).

	Sum of weights ^b	Mean	Standard deviation	5th %ile Value	95th %ile Value	SE of mean ^c
<i>Men</i>						
Acromion breadth, no gear	863	397	19	366	429	0.7
Acromion height, no gear	863	614	30	563	664	1.0
Bi-deltoid breadth in gear	863	709	54	613	796	1.9
Bi-deltoid breadth, no gear	862	574	52	497	663	1.8
Bi-trochanter curve length in gear	863	880	100	740	1062	3.4
Bi-trochanter-acromion curves in gear	863	1780	151	1565	2059	5.1
Buttock-popliteal length in gear ^a	84	452	26	409	495	2.8
Buttock-shoe tip length in gear	863	727	72	596	824	2.4
Hip breadth in gear	863	597	50	515	678	1.7
Hip breadth, no gear	862	437	34	384	498	1.2
Nuchal height, no gear	863	787	36	729	847	1.2
Popliteal height, no gear	863	439	25	399	481	0.8
Sitting height, no gear	863	924	35	866	987	1.2
Waist breadth in gear	862	458	36	400	522	1.2
<i>0.5</i>						
<i>Women</i>						
Acromion breadth, no gear	88	355	20	327	393	2.2
Acromion height, no gear	88	583	27	542	625	2.9
Bi-deltoid breadth in gear	88	644	44	568	722	4.7
Bi-deltoid breadth, no gear	88	489	47	430	597	5.0
Bi-trochanter curve length in gear	88	845	95	715	1015	10.2
Bi-trochanter-acromion curves in gear	88	1705	151	1500	1968	16.1
Buttock-popliteal length in gear ^a	36	432	17	404	460	2.8
Buttock-shoe tip length in gear	88	700	69	566	786	7.3
Hip breadth in gear	88	577	46	513	658	4.9
Hip breadth, no gear	87	425	39	372	489	4.1
Nuchal height, no gear	88	746	33	693	797	3.5
Popliteal height, no gear	88	407	23	370	447	2.5
Sitting height, no gear	88	874	31	832	923	3.3
Waist breadth in gear	88	421	45	351	494	4.7

^a Data of buttock-popliteal length in gear were from a pilot study of 120 participants; unweighted.

^b Sum of weights: the weighted sample size.

^c SE of Mean: standard error of mean.

from the weighted raw data. Taking off 30 mm for comfort and adding 25 mm height to account for shoe height, the seat height would be 422 mm. This value also can be derived from Table 3 by considering the popliteal heights of both male and female firefighters and their population distribution as a weighting factor. The detail steps for this process were documented in Hsiao and Halperin (1998).

4.2.3. Knee clearance

The minimum fore-aft space between the back of a front seat and the front face of the backrest of a rear seat (i.e., seat depth plus knee/foot room) would be the 95th percentile value of buttock-shoe tip length in gear of male firefighters, which is 824 mm. Adding 85 mm for leg movement would be reasonable (i.e., the 95th popliteal height of male firefighters $\times \tan 10^\circ = 481 \times 0.1763 = 85$ mm). The suggested minimum fore-aft space (knee clearance) between the back of a front seat and the front face of backrest of a rear seat at the floor level is 909 mm.

4.2.4. Backrest width and height

The minimum seat backrest width is constrained by the acromion breadth of the larger male segment of firefighters (the 95th percentile value) without gear, which is 429 mm. The maximum seat backrest width is constrained by the bi-deltoid breadth of the larger male segment of firefighters (the 95th percentile value) without gear, which is 663 mm. The maximum seat backrest height (for unrestricted head movement while allowing for adequate back support) is defined by the acromion height of the smaller female segment of firefighters without gear (the 5th percentile value), which is 542 mm.

4.2.5. Head restraint height

The minimum head support height can be specified at the 99th percentile value of nuchal height of male firefighters without gear, which would be the mean + its standard deviation $\times 2.33 = 787$ mm + 36 mm $\times 2.33 = 871$ mm, where 2.33 is the Z value (a coefficient whose value varies with the percentage of population to be covered) for covering 99 percent of male firefighter population. This is critical for reducing neck whiplash injury risk during rear impact.

4.2.6. Head clearance

The seat-to-ceiling height can be specified at the 95th percentile value for sitting height without gear (male firefighters), which would be 987 mm from seat surface. Fifty mm of additional head clearance can be added for seating positions where suspension-style seats are employed; more than 50-mm head clearance allowance may be needed, depending on seat and vehicle suspension characteristics. In addition, current safety practice requires that no helmet be used while riding automotive fire apparatus.

4.2.7. Seat space in a row

While minimum seat pan width and seat backrest width can be specified using hip breadth data and acromion breadth data without gear, seat space per unit in a row at the hip and shoulder levels are to be specified at the 95th percentile value of hip breadth in gear (male firefighters) and the 95th percentile value of bi-deltoid breadth in gear (male firefighters), which would be 678 mm and 796 mm, respectively.

4.2.8. Seatbelt

Based on a six-step anthropometric procedure for equipment sizing and design (Hsiao, 2013) and the data from Table 3, the minimum belt web length for Type I lap belt (pelvic restraint) would be based on the mean bi-trochanter curve length in gear for

male firefighters plus the product of its standard deviation and the adopted Z value (880 mm + 100 mm $\times 3.1 = 1190$ mm), where 3.1 is the Z value for covering 99.9 percent of male firefighter population. This will cover almost all females as well. The decision to accommodate 99.9% of male population represents a critical safety consideration that all firefighters should be able to buckle up themselves, to assure safety, especially in the event of a crash or overturn. It is necessary for designers to add additional web length to contain the component length between the trochanter (left) and belt anchor point (Fig. 4a) as well as the distance between the trochanter (right) and buckle point (Fig. 4b). An adjustment of 300 mm for the left trochanter to belt anchor point and 30 mm for the right trochanter to buckle point would be adequate, based on common seat installations. Therefore, the minimum length of lap belt for pelvic restraint should be 1520 mm.

The minimum belt web length for Type II belt (pelvic and upper torso restraint) can be calculated in a similar manner to minimum lap belt web length, but on the basis of bi-trochanter-acromion curves in gear for male firefighters (1780 mm + 151 mm $\times 3.1 = 2248$ mm). An adjustment of 300 mm for the left trochanter to belt anchor point (Fig. 4a), 30 mm for the right trochanter to buckle point for twice (one for lap-belt component and one for shoulder-belt component for a total of 60 mm; Fig. 4c), and 220 mm for acromion to shoulder belt anchor point (Fig. 4d) would be adequate, based on common seat installations. Therefore, the required minimum length of pelvic and upper torso restraint would be 2828 mm. The overall belt web length adjustment for Type II belt (580 mm in this example) may vary slightly among different seatbelt assemblies which have somewhat different belt anchor locations, D-loop mountings, buckle stalk lengths, and seat adjustments (up-down, fore-aft, and recline angle). Fire apparatus manufacturers are in the best position to specify these additions above the basic bi-trochanter-acromion curves length of 2248 mm per their design configurations.

5. Discussion

5.1. Seat assembly

Seat design in fire apparatus often need to take into account a variety of factors including vehicle design packaging, durability, SCBA (self-contained breath apparatus) storage options, occupant crash protection features, desired occupant capacity, and the physical space available in the cab. Certain seating positions specified by fire departments are intended to be occupied on every fire call, while others are provided only to accommodate additional crew members during extraordinary situations. These additional positions frequently are accommodated with flip-down seats, or secondary position seats (Fig. 5). Some fire departments may specify four-person crew cab seating, but their operational requirements may be limited to one or two crewmembers on a normal fire call. These considerations may become factors where tradeoffs between optimal seating design and other cab interior features are concerned.

While fit and comfort are important seat-design criteria, the importance of the criteria may be tempered with space constraints and expected length of time the occupant will be seated during each fire duty use. An average fire call for a pumper apparatus is 5.8 miles (Lackore, 2004) which translates to approximately 12 min duration at an average speed of 30 mph. Unlike the design of long-haul truck cab or office seating, the comfort characteristic and space for the fire apparatus seat design is often weighed accordingly.

The primary objective of this study is to provide seat assembly designers and fire departments with design guidance that may reduce impediments to the easy use of seatbelts. This entails

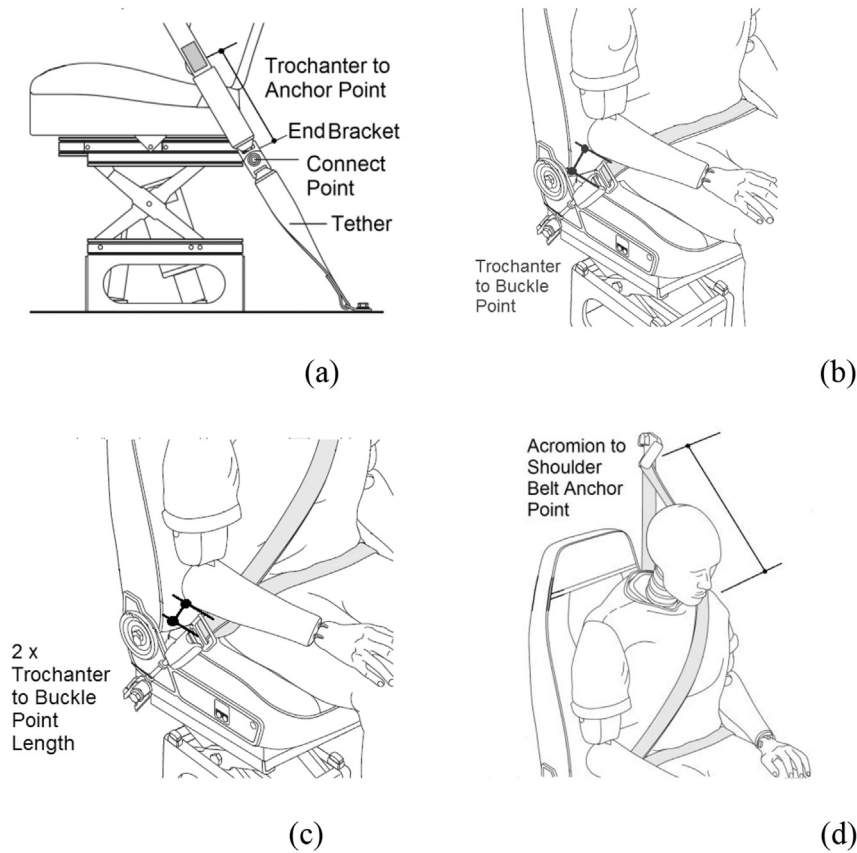

Fig. 4. (a) Component length between the left trochanter and belt anchor point; (b) the distance between right trochanter and buckle point for Type I belt; (c) two runs of right-trochanter-to-buckle-point length for Type II belt; and (d) the web length from acromion to shoulder belt anchor point.

understanding the ergonomics involved with sitting, reaching, and manipulating the seatbelt while encumbered with protective clothing and equipment. The comparison of seated accommodation with and without a buckled belt is pertinent; the long-term comfort of the seat itself is less of a focus since the occupant is seated for short periods of time on each occasion of use.

5.2. Seat pan width and seat space width at the hips

Study results indicate that a seat pan width of 498 mm will accommodate firefighters with hip breadths that span to the 95th percentile. The current NFPA 1901 standard for automotive fire

apparatus specifies that seat cushions shall be a minimum of 460 mm in width. This width would only meet the needs of 75% of male firefighters and 81% of female firefighters both without gear. It should be noted that the distance between the ischial tuberosities which, when sitting, are the load-bearing bones, is less than hip breadth. Whether the width of the seat pan should match hip breadth or the distance between the ischial tuberosities is not the subject of the present study.

The current NFPA standards specify a minimum seat pan width, but do not provide a value for seat space width at the hips. There is a difference between the physical width of a seat at the seat pan (which is based on hip width without gear) and the free space

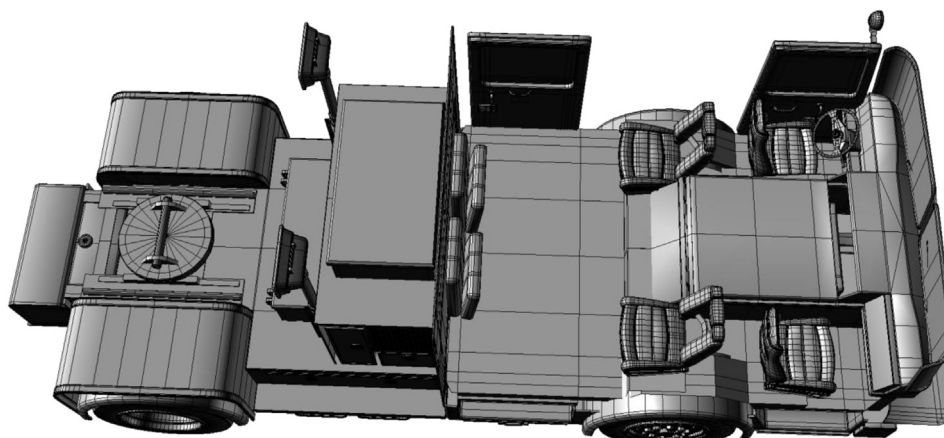

Fig. 5. An example of fire truck crew cab seating arrangement is demonstrated, which includes four regular seats and two flip-down seats.

provided for the occupant at the hip (which is determined by hip width with gear). The results of this study suggest that a 95th percentile male firefighter with bunker gear requires a seat space width at the hips of 678 mm. This dimension is a much more pertinent measurement for seatbelt installation than the physical width of the seat pan (cushion) and is associated with some constraints such as allowing space for the mounting of the stalks to which seatbelt buckles are attached.

The NFPA seat pan (or cushion) width of 460 mm can be traced back to the MIL-STD-1472 military standard for human factors design, in which hip width data of in-vehicle soldiers dressed in arctic clothing were used. An optimum width of 610 mm was also mentioned in this standard. The most recent MIL-STD-1472 standard version G (DoD – Department of Defense, 2012) preserves these specifications (Table 4). There are other commonly referenced guidelines on vehicle seat/cushion width: Ergonomics in the Automotive Design Process (Bhise, 2012), the Federal Motor Vehicle Safety Standards (FMVSS) (DOT – Department of Transportation, 2013a), and J1100 Motor Vehicle Dimensions (SAE – Society of Automotive Engineers International, 2009). Bhise (2012) reported a 432-mm hip width for general automotive design, which was derived from a database on U.S. adult body dimensions (Kroemer et al., 1994). The data were gathered in 1988 using U.S. Army personnel (Gordon et al., 1989). Women had larger hip width than men in this study and thus the 95th percentile value of women's hip width was used. Bhise (2012) also proposed a clearance of 68 mm–93 mm for clothing (winter coats especially), which resulted in 500–525 mm seat cushion width. Guidelines based on military personnel are not applicable to fire apparatus design due to significant anthropometry differences between firefighter and military groups (Hsiao et al., 2002).

5.3. Seat pan depth (seat cushion length)

Seat pan depth (seat cushion length) is constrained by the buttock-popliteal length of the small-female segment of the population, typically the 5th percentile buttock-popliteal length of

females of a target population. The study result suggested a depth of 404 mm (in gear) which is 24 mm more than the current specification of 380 mm in the NFPA 1901 standard (NFPA, 2009). A survey of seat depths of 24 common passenger vehicle models revealed a wide range of values from 480 mm to 690 mm (533 mm ± 49 mm) among the models (Prasad, no date). The most updated MIL-STD-1472 standard version G suggested a 410-mm depth for operator seats measured from the seat reference point (SRP) to the front edge of the seat pan (DoD, 2012), which is equivalent to a seat depth of 540 mm. Another report recommended a depth of 440 mm for general automotive seats (Bhise, 2012). All of these dimensions, whether accounting for clothing or not, do not replicate the 5th-percentile buttock-popliteal length of female firefighters.

Long seat cushions cause occupants to slouch, leading to poor lap belt fit (Klinich et al., 1994) and short seat cushions affect occupants' seated body support from thighs and hips, which can be intrusive on thighs. Most current apparatus seats measure 450–500 mm. The suggested minimum depth of 404 mm (in gear) provides a useful reference for flip-down seats intended to be used infrequently and where space is at a premium.

5.4. Backrest width and height

Current NFPA 1901 standard specifies that the seat backrest shall be a minimum of 460 mm in width at the base. Minimum backrest width is not well defined in the literature. The most recent MIL-STD-1472 standard version G (DoD, 2012) recommended 460–510 mm for a vehicle operator's seat at all levels of the back (Table 4). The 95th percentile acromion breadth without gear for male firefighters obtained in this study was 429 mm, which is different from 460 mm specified in the NFPA 1901 standard. The 95th percentile waist breadth in gear for male firefighters was 522 mm. From the aspect of basic back support, a minimum of 429 mm backrest width is needed. While the current study does not address the relationship of seat back width to back biomechanical support or comfort, these values may be useful to seat

Table 4
Summary of seat and seatbelt specifications (mm).

Seat and seatbelt dimensions	Body dimensions	Reference level	Values	MIL-STD-1472G (2012) operator seat	General automotive (Bhise, 2012)	NFPA 1901 (2009)
Seat backrest height	Acromion height, no gear	5th F	542	460–510	509	460
Seat backrest width at shoulder level (no gear)	Acromion breadth, no gear	95th M	429	460–510		460
Seat space at deltoid level for seats in a row	Bi-deltoid breadth in gear	95th M	796	710 (580 for elbow)		560
Seat backrest maximum width at shoulder level (no gear)	Bi-deltoid breadth, no gear	95th M	663	460–510		460
Lap belt length	Bi-trochanter curve length in gear plus adjustment ^a	99.9th M	1190 + 330 = 1520			(1525)
Shoulder and lap belts total length	Bi-trochanter-acromion curve in gear	95th M	2248 + 580 = 2828			(2800)
Seat pan depth	Buttock-popliteal length in gear	5th F	404	410 (from SRP) ^a : 380–430	440	380
Fore-aft space between front and rear seats	Buttock-shoe tip length in gear (with adjustment)	95th M	824 + 85 = 909			
Seat space (at hip level) for seats in a row	Hip breadth in gear	95th M	678	460 minimum (610 optimum)	500–525	
Seat pan width	Hip breadth, no gear	95th M	498	460	432	460
Head support height	Nuchal height without gear	99th M	871			
Seat pan height	Popliteal height without gear	5th F ~ 95th M	365–476	380	351–21 = 320	
Ceiling height from seat	Sitting height without gear	95th M	987	1070 (head clearance)		889 (+75 SRP); 940 (+75 SRP) (suspension)
Seat backrest width at the base	Waist breadth in gear	95th M	522			

^a Seat reference point (SRP; H-point) to front edge of seat pan.

manufacturers attempting to improve the fit between fire fighter body shapes and the seat back profile. More specific detail will be available from the 3-dimensional body scanning data to be released in the future from this research team.

The obtained backrest height (or seatback height) for the small-female segment of the firefighter population without gear was 542 mm. This value is 82 mm greater than the current specification in the NFPA 1901 standard (NFPA, 2009). The most updated MIL-STD-1472 standard version G (DoD, 2012) suggested a 510-mm height and Bhise (2012) recommended 509 mm for general automotive applications (Table 4). All literature pointed to a taller backrest height than that in the current NFPA standard. An update of the NFPA 1901 standard on backrest height from 460 mm to 542 mm is worth a consideration, which would match the 5th percentile female fire fighter data from this study. The justification for backrest height in the current literature is not well defined. Both mid-back-height and shoulder-height backrests are seen for office chairs. Commercial vehicle seats typically are designed to support the back up to the shoulder level for biomechanical reasons, especially in conjunction with the use of head support to reduce head/neck risk during rear impact.

5.5. Head support height

The above-mentioned backrest height measurement does not include the head support/restraint. Head restraints are mandated by FMVSS 202a Head Restraints for passenger cars, trucks, and buses with a gross vehicle weight rating (GVWR) of 4536 kg or less (DOT, 2013b).

FMVSS 202a imposed at least 800 mm in head support height for front outboard designated seating positions and 750 mm for rear outboard designated seating positions for passenger vehicles (DOT, 2013b). This dimension is measured from the seating H-point along a line parallel with the seat back, to the top of the seat back or head restraint. The results from this study indicate that the nuchal height for the 99th percentile male fire fighter is 871 mm from the seat cushion to the nuchal point (that portion of the head that sticks out the farthest in the back). Subtracting the H-point to the seat cushion value of 75 mm (NFPA, 2009), the value corresponding to FMVSS 202a would be 796 mm. Most fire apparatus are heavier than 4536 kg, so they are not required to incorporate head restraints nor does the NFPA standard specify a head restraint dimension. Given the risk of fire truck collisions while delivering emergency services (Karter and Molis, 2012), adding the specification of head support height of 796–800 mm from the H-point in the NFPA standard may be worth of consideration to enhance head and neck protection for firefighters.

5.6. Seating space width

The current NFPA 1901 standard specifies that seating space shall have a minimum width of 560 mm at the shoulder level. While this specification continues to be used by many fire departments, the results of this study demonstrate that it does not accommodate firefighters sitting together and encumbered with turnout gear and equipment (Fig. 6a). The results from this study indicate that the 95th percentile male firefighter had bi-deltoid breadth of 663 mm without gear and 796 mm in gear.

It is recognized that current fire truck space is very limited and compact by necessity. Changing the mandated minimum seat spacing from 560 mm to 796 mm represents a major dilemma between the cab seating configurations desired by fire departments on one hand, and firefighter comfort and ease of fastening seatbelts on the other. Additionally, wider seats or seat spacing will not

physically fit between the cab side and the engine tunnel in most custom and commercial apparatus cab configurations (Figs. 6 and 5).

This study provides useful information on the ideal hip and shoulder space requirements. It did not evaluate how fire departments adapt to their current apparatus seating configurations. Some possible adaptations include alternating larger and smaller occupants, having fewer cab occupants than seating positions, and donning turn-out jackets only after leaving the cab. The results of this study can be incorporated into the standards development process, or by individual fire departments in their future apparatus specifications. Two possible specification changes are considered here. The first is to specify values from the 95th percentile male with gear. The second is a compromise based on the 67th percentile male shoulder breadth with gear. These considerations are summarized in the following chart (Table 5).

The practical solution is to have the seat shoulder space for single seats be designed to reflect the 67th percentile of bi-deltoid breadth of male firefighters in gear of 733 mm and the 95th percentile male firefighter hip breadth with gear of 678 mm for seatbelt installation. In this configuration, all firefighters can fit in the seat while a third of male firefighters will be squeezing their jackets and gear against doors and walls. This solution will provide sufficient hip clearance as well. The study showed 498 mm for hip breadth without gear for the 95th percentile male firefighters. Adding 140 mm between-seat cushions per SAE J1100 Motor Vehicle Dimensions (SAE, 2009) would result in a 638 mm seating space, which is slightly less than the 678 mm width being proposed.

The width of current custom cabs across the rear wall ranges from 2235 mm to 2286 mm, and up to three seats can be arranged in a row (733 mm \times 3 = 2199 mm). The 3-seat arrangement would prevent firefighters from “rubbing” against each other’s shoulders as seen in the existing designs (Fig. 6) although their bunker gear may still touch.

5.7. Seatbelt assembly

Federal motor carrier standards exempt emergency workers from the requirement to wear seatbelts when responding to an emergency. Several states overrode that regulation and required seatbelts to be worn at all times while a fire apparatus is in motion (Coleman, 2007). One challenge in achieving the buckle-up safety goal was that approximately 25% of fire stations stated that their firefighters were unable to buckle their seatbelts while donning protective gear (Routley, 2006). The results of the current study suggest a minimum seatbelt web length of 2828 mm for 3-point belts. The older versions of seatbelt length seen in various vehicles were in the range of 2080 mm, 2261 mm, and 2540 mm, which technically can accommodate only 3%, 25%, and 88% of male firefighters in gear, respectively, and 5%, 43%, and 95% of female firefighters in gear, respectively. These lengths were adopted from military personnel data, some without gear and some in gear, which explain why a significant portion of firefighters were unable to buckle up.

As indicated in the Results section, the overall belt web length adjustment beyond the bi-trochanter-acromion curve length for 3-point belts (580 mm in this example) needs to account for belt anchor locations, D-loop mountings, buckle stalk lengths, and seat adjustments (up-down, fore-aft, and recline angle). This leads to potential variations in seatbelt web lengths among fire apparatus manufacturers above the basic bi-trochanter-acromion curves length of 2248 mm. The 2009 edition of NFPA 1901 standard unified the seatbelt length measurements by specifying that the seat be adjusted all the way back and down when measured. An effort was made to call back 210 participants from this study for a



Fig. 6. (a) The challenge is apparent for two firefighters to sit in a row with current space specification of 560 mm for each person as seen in the fire truck with two forward-facing crew seats along the rear wall. (b and c) Three and four forward-facing seats in a row along the rear wall are seen in current fire trucks. Changing the unit space from 560 mm to 733 mm would afford three seats in a row with an acceptable unit space for each, which is a practical and cost-reasonable solution for seats along the rear wall.

follow-up study to measure their needed belt length, including the length to seatbelt anchor points and the additional slack required to span both lap belt and shoulder belt, which verified the validity of the overall belt web length and adjustment range proposed in the Results section. The follow-up study is elaborated in [Appendix B](#).

5.8. Seat-to-ceiling height

The recommended seat-to-ceiling height measured from this study is 987 mm measured from the seat cushion to the top of the head. The NFPA 1901 standard of 889 mm for non-suspension-style seats was measured from the seat H-point to the ceiling. Subtracting the H-point to the seat cushion value of 75 mm (NFPA, 2009) from the recommended 987 mm height (i.e., $987\text{ mm} - 75\text{ mm} = 912\text{ mm}$) shows that the NFPA criterion of 889 mm is 23 mm shorter than that from this study.

The NFPA 1901 standard specifies 940 mm for suspension-style seats which provides for a buffer space of 51 mm for vertical vibration. The MIL-STD-1472G standard reported a 972 mm sitting height for the 95th percentile male in the military and recommended a clearance of 1070 mm from seat reference point (SRP) to the roof line for the vehicle operator's station to accommodate a soldier dressed in arctic clothing and on rough terrain. The FMVSS No. 208 reported 965 mm sitting height, based on the 95th percentile data for adult males (DOT, 2013c). The differences may be attributed to different work environments that they may encounter (e.g., terrain).

5.9. Suggested dimensions for updating seat and seatbelt specifications

Based on the dimension data from both the Results and Discussion sections, suggested dimensions are summarized in [Table 6](#) for updating seat and seatbelt specifications. The costs (unsafe and discomfort) for deviating from the specifications for seat height, seat depth, seat spacing at shoulder, seat spacing at hip, and seatbelt length are likely much greater than the costs for similar-size deviations for the remaining dimensions.

5.10. Univariate-based vs. multivariate accommodations

The suggested dimensions in this paper follow standard practice in choosing 5th-percentile or 95th-percentile values from single-gender distributions as design targets. This approach is acceptable for the design of product that typically involves with only 1 or 2 body dimensions and the product (e.g., seat pan design and seat spacing) requires limited dynamic human–product interfaces. In this practice, typically 5% of females or males will likely be unaccommodated. Many current national standards and specifications remain using this practice. The approach however will lead to a cumulated unaccommodating rate when multiple dimensions are required in the design process (e.g., vehicle cab and control arrangement). In this case, a multivariate accommodation analysis would be more appropriate to obtain good estimates of the true levels of accommodation. The recommendation in selecting analysis procedures is available in the literature (Hsiao, 2013) and the

Table 5
Possible considerations for fire truck seating space width.

	Shoulder (with gear)	Shoulder (without gear)	Hip (with gear)	Hip (without gear)
NFPA 1901/1906 Current Standard	560 mm	NA	NA	NA
95th Percentile Male	796 mm	663 mm	678 mm	498 mm
67th Percentile Male	733 mm	632 mm	607 mm	444 mm

Table 6
Suggested dimensions for updating seat and seatbelt specifications.

Dimensions (unit: mm)	Width	Depth	Height	Length
Seat pan	498	404	365–476	
Seat backrest	429–522		542	
Head support			871	
Seat space at shoulder	733			
Seat space at hip	678			
Knee space		909		
Lap belt effective web				1520
Lap and shoulder belt effective web				2828

guidance and examples for conducting multivariate accommodation analyses are available as well (Zehner et al., 1992; Hsiao et al., 2005).

6. Conclusions

Over the past several decades the fire service has experienced several trends that have impacted human interaction with fire-fighting vehicles and equipment. These trends include better but bulkier protective clothing, a greater variety of communication and rescue equipment carried by firefighters, and a national increase in the average size and weight of the workforce. The gradual nature of these trends warrants a fresh look at the anthropometric aspects of firefighters and fire apparatus. This study provides new and critical information to aid industry engineers as well as fire department leadership with data they can use to better match vehicles and equipment to the physical needs of the firefighters who use them.

The study results suggest that the following dimensions, developed with an understanding of fire apparatus space constraints, would provide improved ergonomic seating and seatbelt fit for the majority of the firefighting workforce while encumbered with protective clothing and personal gear: 498 mm for seat pan width, 404 mm for seat pan depth, 365–476 mm for seat pan height, 429–522 mm for seat backrest width, 542 mm for seat backrest height, 871 mm for head support height, 678 mm for seat space at hip, 909 mm for knee space (depth), 1520 mm for lap belt effective web, and 2828 mm for combined lap-and-shoulder belt effective web.



Acknowledgments

The authors thank Will Dodson of Indiana Mills and Manufacturing Incorporated, Joseph Mirabile of the USSC Group, Inc. and Paul Bostrom of the H. O. Bostrom Company for their input on seatbelt and seat specifications and prototyping. The authors also thank Robert Ferri, Bradley Newbraugh, John Powers, Rick Current, Darlene Weaver, Joyce Zwiener, Jinhua Guan, Alfred Amendola, Paul Keane, and Gene Hill for their tireless support of this project, including transporting, installing, and calibrating the scanning equipment for all four geographic sites, organizing scientific literature, and providing logistical and administrative support. The authors would also like to thank Ron Siarnicki for his insightful input and vital selection of measurement sites. We are indebted to many fire station managers who provided unflinching subject recruitment and scheduling of subjects as well as excellent facilities in support of this endeavor: Chief Andy Johnston, Chief Michael Clemens, and Chief Kevin Frazier of the Montgomery Fire Department in Rockville, Maryland; Chief Mike Smith and Captain Mike Gafney of the Phoenix Fire Department in Phoenix, Arizona; Chief Henry Costo and Captain Jesse Wilson of the Philadelphia Fire Department; Captain Homer Robertson and Chief Mark Marshall of the Fort Worth Fire Department; Firefighter Mary Ann Hubbard of the Austin Fire Department; and Chief Brooke Hildreth of the San Antonio Fire Department. Thanks also go to the National Fallen Firefighters Foundation (NFFF), International Association of Fire Chiefs (IAFC), International Association of Fire Fighters (IAFF), Fire Apparatus Manufacturers Association (FAMA), and the National Fire Protection Association (NFPA) for their support and insightful suggestions in project planning and execution.

Disclaimer









The findings and conclusions in this article are those of the authors and do not necessarily represent the views of the National Institute for Occupational Safety and Health (NIOSH). Mention of company names or products does not imply an endorsement from NIOSH.

Appendix A. Dimensions relevant to the design of seats and seat belts



Dimension	Figure	Definition
Acromial breadth without gear		The horizontal distance between the right and left acromion measured with the subject in the seated position.
Acromion height without gear		The subject sits erect on a flat surface looking straight ahead. The vertical distance is measured between the sitting surface and the tip of the right shoulder (acromion).

(continued on next page)

(continued)

Dimension	Figure	Definition
Bideltoid breadth in gear		The subject sits erect on a flat surface <i>in turnout gear</i> . The upper arms are hanging relaxed at the sides. The maximum horizontal distance of the turnout gear is measured between the outside of the upper arms at the level of the deltoid muscles and as low as the level of the elbows.
Bideltoid breadth without gear		The subject sits erect on a flat surface <i>without turnout gear</i> . The maximum horizontal distance between two upper arms, typically found at elbow height or bideltoid height, with the subject in the seated position and their hands comfortably in lap.
Bi-trochanter curve length in gear		The subject sits erect on a flat surface in turnout gear. The maximum curve length around the turnout gear across the hip joints and abdominal area is measured (corresponding to lap belt curve).
Bi-trochanter-acromion length in gear		The subject sits erect on a flat surface in turnout gear. The maximum curve length is measured around the turnout gear across the left hip joint, abdominal area, right hip joint, upper torso, and left acromion (corresponding to lap belt curve plus shoulder belt curve).
Buttock-popliteal length in gear		Horizontal distance between a buttock plate at the posterior point on either buttock and the popliteal point of the right knee. The subject sits erect with thighs paralleled and knees flexed 90°.
Buttock-shoe tip length in gear		The subject sits on a flat surface in turnout gear. The thighs are parallel, and the feet are in line with the thighs on a surface adjusted so that the knees are bent 90°. The horizontal straight-line distance is measured between the back right buttock and the most anterior part of the boot.
Hip breadth in gear		The subject sits erect on a flat surface in turnout gear. The maximum horizontal breadth of the turnout gear across the hips is measured.
Hip breadth without gear		The subject sits erect on a flat surface. The maximum horizontal breadth across the hips or thighs is measured.

(continued)

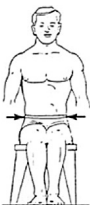
Dimension	Figure	Definition
Nuchal height without gear		The subject sits erect looking straight ahead. The vertical distance is measured between the seated plane and the most protrusive point of the nuchal.
Popliteal height without gear		Vertical distance from a footrest surface to the back of the right knee (the popliteal fossa at the dorsal juncture of the right calf and thigh). Subject sits with the thighs parallel, the feet in line with the thighs, and the knees flexed 90°.
Sitting height without gear		The subject sits erect on a flat surface looking straight ahead with the head in the Frankfort plane. The vertical distance is measured between the sitting surface and the top of the head.
Waist breadth in gear		The subject sits erect on a flat surface in turnout gear. Waist breadth is taken at the widest point at the firefighter's waist level and includes gear and any equipment.

Appendix B. Seatbelt design for fire trucks

As indicated in the Results section, the overall belt web length adjustment beyond the bi-trochanter-acromion curve length for 3-point belts (580 mm in this example) needs to account for belt anchor locations, D-loop mountings, buckle stalk lengths, and seat

adjustments (up-down, fore-aft, and recline angle). This leads to potential variations in seatbelt web lengths among fire apparatus manufacturers above the basic bi-trochanter-acromion curves length of 2248 mm. The 2009 edition of NFPA 1901 standard unified the seatbelt length measurements by specifying that the seat be adjusted all the way back and down when measured. An effort was



Fig. 7. (a) A fire apparatus simulation buck was used to measure the lap belt length (Type I belt) and 3-point belt length (Type II belt). (b) A test of maneuvering seat belt. (c) Measured belt lengths, including the length to seatbelt anchor points and the additional slack required to span both lap belt and shoulder belt.

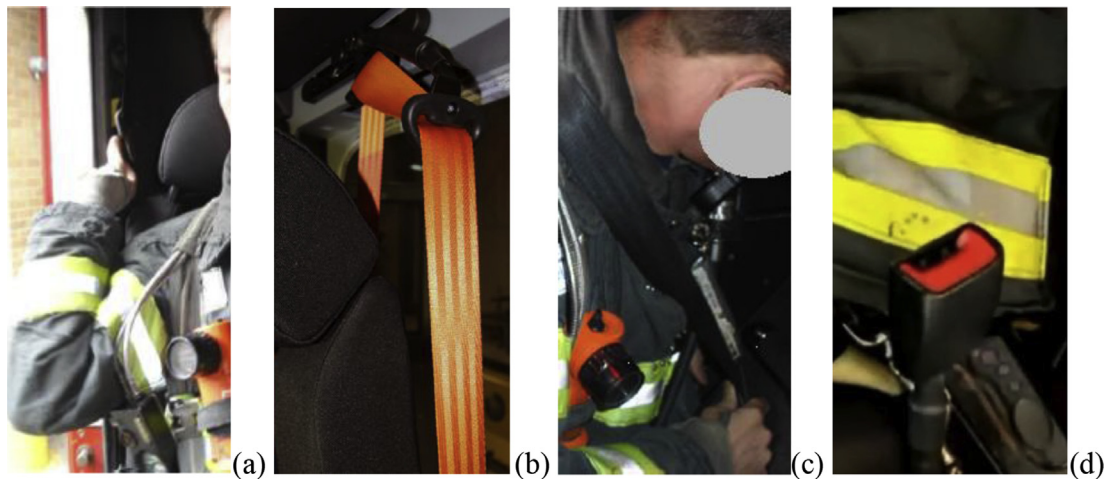

Fig. 8. (a) Firefighters have reported difficulties reaching retracted seatbelts in some seatbelt configurations. (b) An extender bar places the shoulder belt D-loop in a more accessible location than the old seatbelt configuration. (c) Firefighters have reported difficulties locating seatbelt receptors in some old seatbelt configurations. (d) A longer stalk for the receptor improves access to the receptor and thus eases the buckling process as compared to the old fire truck seatbelt configurations.

made to call back 210 participants from this study for a follow-up study to measure their needed belt length, including the length to seatbelt anchor points and the additional slack required to span both lap belt and shoulder belt.

The results were 1193 mm for mean and 85 mm for standard deviation for a lap belt (Type I belt) and 2368 mm for mean and 147 mm for standard deviation for a 3-point belt (Type II belt). The minimum belt web length would be based on the mean plus the product of its standard deviation and the adopted Z value, which was 1457 mm for Type I belt ($1193 \text{ mm} + 85 \text{ mm} \times 3.1 = 1457 \text{ mm}$) and 2824 mm for Type II belt ($2368 \text{ mm} + 147 \text{ mm} \times 3.1 = 2824 \text{ mm}$). The outcomes are very close to the results of 1520 mm and 2828 mm reported in the Results section. The outcomes are also very close to those of the 2009 edition NFPA standard of 1525 mm for Type I belts and 2800 mm for Type II belts. An analysis of the adjustment needed for seatbelt anchor points and the additional slack required, spanning both lap belt and shoulder belt from the call-back participants (Fig. 7), indicated a mean value of 298 mm for lap belts and 572 mm for 3-point belts which were within the general range of the proposed 300 mm adjustment for lap belts and 580 mm adjustment for 3-point belts presented in the Results section. Manufacturers of seatbelts for fire apparatus have been using the summary data from the present study and the 2009 edition NFPA 1901 standard to update seatbelt designs.

As new research findings have emerged, common manufacturing practice has been to extend the seatbelt web length in the order of 288–748 mm over the old accepted manufacturing practice. As a result, there is a requirement that additional retracting “power” be added to the seatbelt retracting mechanism. The seatbelt manufacturing industry has responded to this changed need, and redesigned its retracting system design to provide additional retracting power. The industry has also provided an extender bar which places the shoulder belt D-loop in a more accessible location than the old seatbelt configuration (Fig. 8a and b). In addition, a longer stalk for the receptor to improve access to the buckle was developed which eases the buckling process (Fig. 8c and d), especially when firefighters are wearing turnout coats and gloves. Moreover, the seatbelt manufacturing industry has added the glowing feature in buckles to ease the vision requirement for buckling during the mission at night. In other domains, the problems with access and vision associated with buckles have led to the specification of front-buckling harnesses rather than three-point belts.

References

- Bhise, V.D., 2012. *Ergonomics in the Automotive Design Process*. CRC Press, Taylor & Francis, Boca Raton, FL.
- Campbell, K., 1999. *Traffic Collisions Involving Fire Trucks in the United States*. UMTRI-99-26. University of Michigan Transportation Research Institute, Ann Arbor, MI.
- Coleman, J., 2007. Skip. Seat belt policies. *Fire Engineering*. Retrieved from: <http://www.fireengineering.com/articles/print/volume-160/issue-11/departments/roundtable/seat-belt-policies.html>.
- Das, B., Grady, R.M., 1983. *Industrial workplace layout and engineering anthropometry*. In: Kvalseth, T. (Ed.), *Ergonomics of Workstation Design*. Butterworths, London.
- Fahy, R.F., 2008. *U.S. Firefighter Fatalities in Road Vehicle Crashes - 1998-2007*. National Fire Protection Association, Fire Analysis and Research Division, Quincy, MA. Retrieved from: <http://www.nfpa.org/-/media/Files/Research/NFPA%20reports/Fire%20service%20statistics/osffvehicledeaths.pdf>.
- Fire Apparatus Manufacturers' Association (FAMA), 2007. *Firefighter Anthropometric Data White Paper*. Retrieved from: http://www.fama.org/pdf/white_paper/FirefighterAnthroDataWhitePaper.pdf.
- Gordon, C.C., Bradtmiller, B., Clauser, C.E., Churchill, T., McConville, J.T., Tebbets, I., Walker, R.A., 1987-1988. *1987-1988 Anthropometric Survey of U.S. Army Personnel: Methods and Summary Statistics (Technical Report TR-89-044)*. U.S. Army Natick Research, Development and Engineering Center, Natick, MA.
- Hsiao, H., 2008. Sizing firefighters and fire apparatus: safe by design. Morgantown, WV: unpublished National Institute for Occupational Safety and Health project proposal. Retrieved from: <http://www.cdc.gov/niosh/topics/anthropometry/pdfs/Sizing%20firefighters%20proposal%20core%20part.pdf>.
- Hsiao, H., 2013. Anthropometric procedures for protective equipment sizing and design. *Hum. Factors* 55 (1), 6–35.
- Hsiao, H., Halperin, W., 1998. Occupational safety and human factors, Chapter 64. In: Rom, W.N. (Ed.), *Environmental and Occupational Medicine*, third ed., pp. 919–932 (Book Chapter).
- Hsiao, H., Long, D., Snyder, K., 2002. Anthropometric differences among occupational groups. *Ergonomics* 45, 136–152.
- Hsiao, H., Whitestone, J., Bradtmiller, B., Zwiener, J., Whistler, R., Kau, T., Gross, M., Lafferty, C., 2005. Anthropometry criteria for the design of tractor cabs and protection frames. *Ergonomics* 48 (4), 323–353.
- Hsiao, H., Whitestone, J., Kau, T.Y., Whistler, R., Routley, J.G., Wilbur, M., 2014. Sizing firefighters: method and implications. *Hum. Factors* 56 (5), 873–910.
- International Organization for Standardization (ISO), 2008. *ISO/TR 7250-2: Basic Human Body Measurements for Technological Design. Part 2: Statistical Summaries of Body Measurements from Individual ISO Populations (Technical report)*. International Organization for Standardization, Geneva, Switzerland.
- Karter, M., 2006. *U.S. Fire Department Profile through 2005*. National Fire Protection Association, Quincy, MA.
- Karter, M.J., Molis, J.L., 2012. *U.S. Firefighter Injuries - 2011*. National Fire Protection Association, Fire Analysis and Research Division, Quincy, MA. Retrieved from: <http://www.nfpa.org/-/media/Files/Research/NFPA%20reports/Fire%20service%20statistics/FirefighterInjuries2011.pdf>.
- Karter, M.J., Molis, J.L., 2013. *U.S. Firefighter Injuries - 2012*. National Fire Protection Association, Fire Analysis and Research Division, Quincy, MA. Retrieved from: <http://www.nfpa.org/-/media/Files/Research/NFPA%20reports/Fire%20service%20statistics/osffinjuries.pdf>.

- Karter, M.J., Stein, G.P., 2011. U.S. Fire Department Profile through 2010. National Fire Protection Association (NFPA), Fire Analysis and Research Division, Quincy, MA. Retrieved from: <http://www.nfpa.org/assets/files/pdf/os.fdprofile.pdf>.
- Klinich, K.D., Pritz, H.B., Beebe, M.S., Welty, K.A., 1994. Survey of older children in automotive restraints and booster seats. Technical Paper 94222 SAE Trans. J. Passeng. Cars-Mech. Syst. 103.
- Kroemer, K.H.E., Kroemer, H.B., Kroemer-Elbert, K.E., 1994. *Ergonomics: How to Design for Ease and Efficiency*. Prentice Hall, Englewood Cliffs, NJ.
- Lackore, J.R., 2004. Fire Apparatus Duty Cycle White Paper. Fire Apparatus Manufacturer's Association (FAMA) Technical committee, Lynnfield, MA.
- National Fire Protection Association (NFPA), 2008. NFPA1901: Standard for Automotive Fire Apparatus, 2009 Edition. National Fire Protection Association, Quincy, MA.
- National Fire Protection Association (NFPA), 2003. NFPA1901: Standard for Automotive Fire Apparatus, 2003 Edition. National Fire Protection Association, Quincy, MA.
- National Institute for Occupational Safety and Health (NIOSH), 2012. Collection of Anthropometric Information for Fire Apparatus Design and Standards Update, Phase I Final Report. Morgantown, West Virginia: Unpublished Internal Report Prepared by Total Contact Inc.
- National Institute for Occupational Safety and Health (NIOSH), 2005. Career captain dies and the driver/operator and a fire fighter are severely injured in apparatus crash – Louisiana. A summary of a NIOSH Fire Fighter Fatality Investigation. Retrieved from: <http://www.cdc.gov/niosh/fire/reports/face200535.html>.
- National Institute of Standards and Technology (NIST), 2008. Pilot Study of Fire-fighter Three- Dimensional Anthropometry to Improve Seatbelt Safety. NIST GCR 08-919 report. National Institute of Standards and Technology, Gaithersburg, MD.
- Peters, W.C., 2014. FAMA fire apparatus improvement white paper. Available from: http://www.fama.org/pdf/white_paper/F06ImprovementWhitePaperNarrative.pdf (retrieved 19.06.14.).
- Peterson, K., Amandus, H., Wassell, J.T., 2009. Reducing firefighter vehicle crash fatalities. *Fire Engineering*. Retrieved from: <http://www.fireengineering.com/articles/print/volume-162/issue-6/features/reducing-firefighter-vehicle-crash-fatalities.html>.
- Prasad, A.K., Weston, D., no date. NHTSA's rear seat safety research. National Highway Transportation Safety Administration. <http://www-nrd.nhtsa.dot.gov/pdf/esv/esv22/22ESV-000348.pdf>.
- Routley, J., 2006. Safe seating and seatbelts in fire apparatus. White paper presented at the Firehouse Expo, Baltimore, MD.
- SAE, 1995. SAE J826-1995: Devices for Use in Defining and Measuring Vehicle Seating Accommodation. Society of Automotive Engineers International.
- SAE, 2009. Motor Vehicle Dimensions: J1100, Surface Vehicle Recommended Practice. Society of Automotive Engineers International.
- Siarnicki, R., 2011. Assessing what they LACK: the culture of firefighting. *Firehouse*. Retrieved from: <http://www.firehouse.com/article/10579437/assessing-what-they-lack-the-culture-of-firefighting>.
- U.S. Census Bureau, . Population Estimates by State: Annual Estimates of the Population by Sex, Race, and Hispanic or Latino Origin for States: April 1, 2000 to July 1, 2005. Available from: <http://www.census.gov/popest/states/asrh/SC-EST2005-03.html> <http://www.census.gov/population/www/cen2000/phc-t1.html> <http://www.census.gov/population/cen2000/atlas/tab12-1.pdf> (retrieved 12.01.07.).
- U.S. Department of Defense, 2012. MIL-STD-1472G. Design Criteria Standard: Human Engineering. U.S. Army Aviation and Missile Command, Redstone Arsenal, AL.
- U.S. Department of Transportation, 2013a. Standard No. 209: Seat belt assemblies. Federal Motor Vehicle Safety Standards. Retrieved from: <http://www.fmcsa.dot.gov/rules-regulations/administration/fmcsr/fmcsrruletext.aspx?reg=571.209>.
- U.S. Department of Transportation, 2013b. Standard No. 202a: head restraints; mandatory applicability begins on September 1, 2009. Retrieved from: <http://www.fmcsa.dot.gov/rules-regulations/administration/fmcsr/fmcsrruletext.aspx?reg=571.202a>.
- U.S. Department of Transportation, 2013c. Federal motor vehicle safety standards: standard No. 208; occupant crash protection. <http://www.fmcsa.dot.gov/rules-regulations/administration/fmcsr/fmcsrruletext.aspx?reg=571.208>.
- U.S. Department of Labor: Bureau of Labor Statistics, 2006. Fatal Occupational injuries, employment, and rates of fatal occupational injuries by selected worker characteristics, occupations, and industries, 2006. Available from: http://www.bls.gov/iif/oshwc/foi/CFOL_Rates_2006.pdf (retrieved 12.01.07.).
- Zehner, G.F., Meindl, R.S., Hudson, J.A., 1992. A Multivariate Anthropometric Method for Crew Station Design: Abridged. AL-TR-1992-0164. Crew Systems Directorate, Human Engineering Division, Armstrong Laboratory, Wright-Patterson Air Force Base, OH.