



# 1341

Oxygen Bomb Calorimeter





## SCOPE

These instructions cover the steps to be taken in setting up and operating a Parr 1341 Plain Oxygen Bomb Calorimeter. The user should study these instructions carefully before starting to use the calorimeter so that he will fully understand the capabilities of the equipment, and so that he will be well aware of the safety precautions to be observed in its operation. Instructions covering the operation of the 1108 Oxygen Bomb and the use of other related apparatus are provided in separate instruction sheets listed below. The separate sheets which apply to a particular calorimeter installation should be added to and made a part of these instructions.

### CONTENTS

Safety Information.....	2
Assemble the Calorimeter.....	4
Operating the 1108 Oxygen Bomb .....	5
Operating the Calorimeter.....	5
Calculating the Heat of Combustion .....	8
Standardizing the Calorimeter .....	10
Discussion of Calculations .....	11
Maintenance .....	12
6772 Thermometer .....	13
Parts for the 1341 Calorimeter.....	15

### RELATED INSTRUCTIONS

Sheet No.	Description
205M	Operating Instructions for the 1108 Oxygen Combustion Bomb
207M	Analytical Methods for Oxygen Bombs
545M	Operating Instructions for 6775 Digital Thermometer
201M	Limited Warranty

## SAFETY INFORMATION

### Important Information

Your Parr 1341 Plain Oxygen Bomb Calorimeter has been designed with function, reliability, and safety in mind. It is your responsibility to install it in conformance with local electrical codes.

This manual contains important operating and safety information. You must carefully read and understand the contents of this manual prior to the use of this equipment. For safe operation, please pay attention to the alert signals throughout the manual.

### Warnings

#### To avoid electrical shock, always:

1. Use a properly grounded electrical outlet of correct voltage and current handling capacity.
2. Disconnect from power supply before servicing. The power supply cord of the equipment is the main disconnect device.

#### To avoid personal injury:





1. Do not use in the presence of flammable or combustible materials; fire or explosion may result. This device contains components which may ignite such materials.
2. Refer servicing to qualified personnel.

### General and Intended Usage

Do not use this equipment for anything other than its intended usage. Protection provided by the equipment may be impaired if used in a manner not specified by Parr Instrument Company. This instrument is to be used indoors.



## Alert Signals

	<b>Warning</b> Warnings alert you to a possibility of personal injury.
	<b>Caution</b> Cautions alert you to a possibility of damage to the equipment.
	<b>Protective Earth (PE) Terminal.</b> Provided for connection of the protective earth (green or green/yellow) supply system conductor.
	<b>Note</b> Notes alert you to pertinent facts and conditions.

## General Specifications

### Electrical Ratings

Model 1341EB: 115VAC, 0.30 Amps, 60 Hz

Model 1341EE: 230VAC, 0.15 Amps, 50/60 Hz

### Ignition Units:

2901EB: 115 VAC, 50/60 Hz, 1.5 Amps

2091EE: 230 VAC, 50/60 Hz, 0.8 Amps

Before connecting equipment to an electrical outlet, the user must be certain that the electrical outlet has an earth ground connection and that the power line, load and other characteristics of the installation do not exceed the following limits:

**Voltage:** Fluctuations in the line voltage should not exceed 10% of the rated nominal voltage shown on the data plate.

**Frequency:** The frequency is specified on the data plate of that equipment.

**Current:** The total current drawn should not exceed the rating shown on the data plate by more than 10 percent.

### Environmental Conditions

Operating: 15 °C to 40 °C; maximum relative humidity of 80% non-condensing.  
Installation Category II (overvoltage) in accordance with IEC 664.  
Pollution degree 2 in accordance with IEC 664.  
Altitude Limit: 2,000 meters.

Storage: -25 °C and 65 °C; 10% to 85% relative humidity.

### Provisions for Lifting and Carrying

Before moving the instrument, disconnect all connections from the rear of the apparatus. Lift the instrument by grabbing underneath each corner.



## ASSEMBLE THE CALORIMETER

- 1. Unpack the calorimeter carefully** and check the individual parts against the packing list. If shipping damage is discovered, report it immediately to the delivering carrier. Unpack the jacket first and set it on a sturdy bench or table in a location that is reasonably free from drafts and is protected from sources of radiant heat, preferably in an air conditioned room. Temperature changes in the room should be minimal.  
There should be convenient access to running water, to a drain and to an appropriate grounded electrical outlet. About 8 square feet of workspace will be required. Access to a chemical balance sensitive to 0.1 mg and to a solution, trip or torsion balance capable of weighing up to 2.0 kg with 0.1 g sensitivity will be required. A standard 1A cylinder with a purity of 99.5% is usually sufficient for bomb combustion purposes.
- 2. Set the cover on the jacket.** Remove the two screws from the side of the jacket and attach the stirrer drive motor. Check the stirrer shaft to be sure that it turns freely and slip the drive belt onto the motor and stirrer pulleys.
- 3. Assemble the cover support stands.** Two stands are furnished, each consisting of a base, a support rod and ring to be clamped to the upper end of the rod. The A37A stand with the large ring is used to support the calorimeter cover when it is removed from the jacket, while the A38A stand with the smaller ring supports the bomb head when attaching the fuse wire and arranging the fuel capsule.
- 4. Install the thermistor** by sliding it through the opening in the calorimeter cover. Adjust the length of the thermistor to match the length of the stirring shaft. Hand tighten the nut to secure the thermistor. NOTE: Do not over tighten the nut.

Once installed, the thermistor can remain attached to the cover during all operations. Do not lay the cover on the tabletop. Always set it in the supporting ring on the A37A stand to protect the thermistor and stirring shafts.

- 5. Check the calorimeter bucket**, noting the three dimples in the bottom of the bucket which rest on supporting pins in the bottom of the jacket. The single dimple must always face forward when setting the bucket in the jacket.
- 6. Connect the ignition unit.** While any electrical system capable of furnishing approximately 23 volts can be used to ignite the fuse in the oxygen bomb, most users will prefer to use a Parr 2901 Ignition Unit for this purpose. This unit operates from any standard electrical outlet to provide the proper low voltage firing current, providing also a convenient push switch, indicating lamp and connecting terminals.

Connect one of the lead wires from the calorimeter jacket to the terminal labeled "10CM". Connect the second lead to the terminal labeled "Common". Plug the power cord into an appropriately grounded electrical outlet. The power supply cord is the main electrical disconnect device for the ignition unit. After the unit has been plugged into an outlet do not press the firing button unless the lead wires inside the jacket are connected to a bomb. If the bare terminals on these wires happen to be in contact with each other or with a metal object when the circuit is closed, the resulting short-circuit may cause serious damage to the ignition system.





- 7. Attach the oxygen filling connection.** Unscrew the protecting cap from the oxygen tank and inspect the threads on the valve outlet to be sure they are clean and in good condition. Place the ball end of the 1825 Oxygen Filling Connection into the outlet socket and draw up the union nut tightly with a wrench, keeping the 0-55 atm. gage in an upright position.

Operating instructions for the 1825 oxygen connection are provided in Instruction Sheet 205M for the 1108 oxygen bomb.

### OPERATING THE 1108 OXYGEN BOMB

Detailed instructions for preparing the sample and charging the 1108 oxygen bomb are given in Instruction Sheet, No. 205M. Follow these instructions carefully, giving particular attention to the precautions to be observed in charging and handling the bomb.

### OPERATING THE CALORIMETER

All operations required to test a sample or to standardize the 1341 plain calorimeter should proceed step-wise in the following manner:

- 1. Prepare the sample and charge the oxygen bomb** as described in Instruction Sheet No. 205M.
- 2. Fill the calorimeter bucket by first taring the dry bucket** on a solution or trip balance; then add 2000(+/-0.5) grams of water. Distilled water is preferred, but demineralized or tap water containing less than 250 ppm of dissolved solid is satisfactory. The water temperature should be approximately 1.5°C below room temperature, but this can be varied to suit the operator's preference. It is not necessary to use exactly 2000 grams, but the amount selected must be duplicated within +/-0.5 gram for each run. Instead of weighing the bucket it can be filled from an automatic pipet or from any other volumetric device if the repeatability of the filling system is within +/-0.5 ml. and the water temperature is held within a 1°C range.
- 3. Set the bucket in the calorimeter.** Attach the lifting handle to the two holes in the side of the screw cap and partially lower the bomb in the water. Handle the bomb carefully during this operation so that the sample will not be disturbed. Push the two ignition lead wires into the terminal sockets on the bomb head. Orient the wires away from the stirrer shaft so they do not become tangled in the stirring mechanism. Lower the bomb completely into the water with its feet spanning the circular boss in the bottom of the bucket. Remove the lifting handle and shake any drops of water into the bucket and check for gas bubbles.
- 4. Set the cover on the jacket.** Turn the stirrer by hand to be sure that it runs freely; then slip the drive belt onto the pulleys and start the motor. Turn on the 6775 Digital Thermometer.
- 5. Let the stirrer run for 5 minutes** to reach equilibrium before starting a measured run. At the end of this period record the time on the timer of the 6775 Digital Thermometer and read the temperature.
- 6. Read and record temperatures** at one-minute intervals for 5 minutes. Then, at the start of the 6<sup>th</sup> minute...



7. **Stand back from the calorimeter and fire the bomb** by pressing the ignition button and holding it down until the indicator light goes out. Normally the light will glow for only about  $\frac{1}{2}$  second but release the button within 5 seconds regardless of the light. **Caution: Do not have the head, hands or any parts of the body over the calorimeter when firing the bomb; and continue to stand clear for 30 seconds after firing.**
8. **The bucket temperature will start to rise** within 20 seconds after firing. This rise will be rapid during the first few minutes; then it will become slower as the temperature approaches a stable maximum as shown by the typical temperature rise curve below. It is not necessary to plot a similar curve for each test, but accurate time and temperature observations must be recorded to identify certain points needed to calculate the calorific value of the sample.

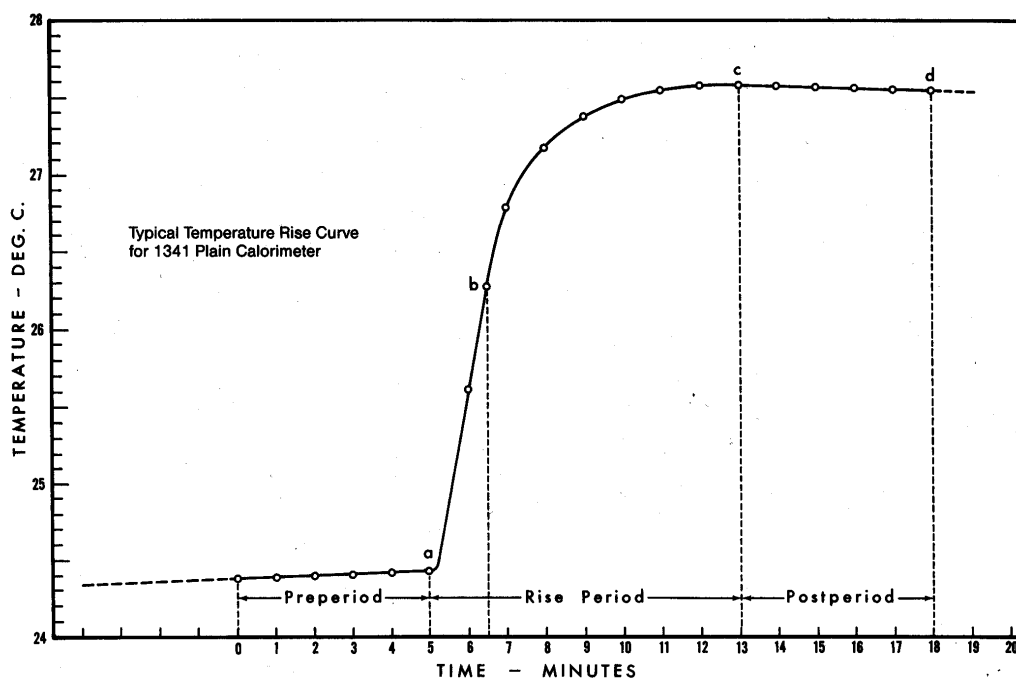

9. **Measure the time required to reach 60 percent of the total rise** by estimating the temperature at the 60% point and observing the time when the temperature reading reaches that point. If the 60% point cannot be estimated before ignition, take temperature readings at 45, 60, 75, 90 and 105 seconds after firing and interpolate between these readings to identify the 60% point after the total rise has been measured.
10. **After the rapid rise period** (about 4 or 5 minutes after ignition) record temperatures at one minute intervals until the **difference** between successive readings has been constant for five minutes. Usually the temperature will reach a maximum; then drop very slowly. But this is not always true since a low starting temperature may result in a slow continuous rise without reaching a maximum. As stated above, the **difference** between successive readings must be noted and the readings continued at one-minute intervals until the **rate** of the temperature change becomes constant over a period of 5 minutes.



11. **After the last temperature reading**, stop the motor, remove the belt and lift the cover from the calorimeter. Wipe the thermistor shaft and stirrer with a clean cloth and set the cover on the A37A support stand. Lift the bomb out of the bucket; remove the ignition leads and wipe the bomb with a clean towel.
12. **Open the knurled knob on the bomb head** to release the gas pressure before attempting to remove the cap. This release should proceed slowly over a period of not less than one minute to avoid entrainment losses. After all pressure has been released, unscrew the cap; lift the head out of the cylinder and place it on the support stand. Examine the interior of the bomb for soot or other evidence of incomplete combustion. If such evidence is found, the test will have to be discarded.
13. **Wash all interior surfaces** of the bomb with a jet of distilled water and collect the washings in a beaker.
14. **Remove all unburned pieces of fuse wire** from the bomb electrodes; straighten them and measure their combined length in centimeters. Subtract this length from the initial length of 10 centimeters and enter this quantity on the data sheet as the net amount of wire burned. Alternatively, the correction in calories is located on the card of the 45C10 fuse wire.
15. **Titrate the bomb washings** with a standard sodium carbonate solution using methyl orange or methyl red indicator. A 0.0709N sodium carbonate solution is recommended for this titration to simplify the calculation. This is prepared by dissolving 3.76 grams  $\text{Na}_2\text{CO}_3$  in water and diluting to one liter. NaOH or KOH solutions of the same normality may be used.
16. **Analyze the bomb washings** to determine the sulfur content of the sample if it exceeds 0.1 per cent. Methods for determining sulfur are discussed in Instruction Sheet No. 207M.



## CALCULATING THE HEAT OF COMBUSTION

**Assembly of Data.** The following data should be available at the completion of a test in a 1341 calorimeter:

- a = time of firing
- b = time (to nearest 0.1 min.) when the temperature reaches 60 per cent of the total rise
- c = time at beginning of period (after the temperature rise) in which the rate of temperature change has become constant
- t<sub>a</sub> = temperature at time of firing
- t<sub>c</sub> = temperature at time c
- r<sub>1</sub> = rate (temperature units per minute) at which the temperature was rising during the 5-min. period before firing
- r<sub>2</sub> = rate (temperature units per minute) at which the temperature was rising during the 5-min. period after time c. If the temperature was falling instead of rising after time c, r is negative and the quantity -r (c-b) becomes positive and must be added when computing the corrected temperature rise
- c<sub>1</sub> = milliliters of standard alkali solution used in the acid titration
- c<sub>2</sub> = percentage of sulfur in the sample
- c<sub>3</sub> = centimeters of fuse wire consumed in firing
- W = energy equivalent of the calorimeter, determined under standardization
- M = mass of sample in grams

**Temperature Rise.** Compute the net corrected temperature rise, t, by substituting in the following equation:

$$t = t_c - t_a - r_1 (b-a) - r_2 (c-b)$$

**Thermochemical Corrections:** Compute the following for each test:

- e<sub>1</sub> = correction in calories for heat of formation of nitric acid (HNO<sub>3</sub>)  
= c<sub>1</sub> if 0.0709N alkali was used for the titration
- e<sub>2</sub> = correction in calories for heat of formation of sulfuric acid (H<sub>2</sub>SO<sub>4</sub>)  
= (13.7) (c<sub>2</sub>) (m)
- e<sub>3</sub> = correction in calories for heat of combustion of fuse wire  
= (2.3) (c<sub>3</sub>) when using Parr 45C10 nickel chromium fuse wire, or  
= (2.7) (c<sub>3</sub>) when using No. 34 B. & S. gage iron fuse wire





**Gross Heat of Combustion.** Compute the gross heat of combustion,  $H_g$ , in calories per gram by substituting in the following equation:

$$H_g = \frac{t W - e_1 - e_2 - e_3}{m}$$

**Example.**

$$\begin{aligned} a &= 1:44:00 = 1:44.0 \\ b &= 1:45:24 = 1:45.2 \\ c &= 1:52:00 = 1:52.0 \\ t_a &= 24.428 + .004 = 24.432 \text{ }^\circ\text{C} \\ t_c &= 27.654 + .008 = 27.662 \text{ }^\circ\text{C} \\ r_1 &= + .010 \text{ }^\circ\text{C} / 5 \text{ min.} = + .002 \text{ }^\circ\text{C} / \text{min.} \\ r_2 &= - .004 \text{ }^\circ\text{C} / 5 \text{ min.} = -.001 \text{ }^\circ\text{C} / \text{min.} \\ c_1 &= 23.9 \text{ ml.} \\ c_2 &= 1.02\% \text{ Sulfur} \\ c_3 &= 7.6 \text{ cm. Parr 45C10 wire} \\ W &= 2426 \text{ calories/ }^\circ\text{C} \\ m &= .9936 \text{ grams} \\ t &= 27.662 - 24.432 - (.002) (1.4) - (-.001) (6.6) \\ &= 3.234 \text{ }^\circ\text{C} \\ e_1 &= 23.9 \text{ calories} \\ e_2 &= (13.7) (1.02) (.9936) = 13.9 \text{ calories} \\ e_3 &= (2.3) (7.6) = 17.5 \text{ calories} \\ H_g &= \frac{(3.234) (2426) - 23.9 - 13.9 - 17.5}{.9936} \\ &= 7841 \text{ calories/ gram} \\ &= (1.8) (7841) = 14,114 \text{ Btu/lb} \end{aligned}$$

**Conversion to Other Bases.** The calculations described above give the calorific value of the sample with moisture as it existed when the sample was weighed. For example, if an air-dried coal sample was tested, the results will be in terms of heat units per weight of air-dry sample. This can be converted to a moisture free or other dry basis by determining the moisture content of the air-dry sample and using conversion formulae published in ASTM Method D3180 and in other references on fuel technology.

The calorific value obtained in a bomb calorimeter test represents the gross heat of combustion for the sample. This is the heat produced when the sample burns, plus the heat given up when the newly formed water vapor condenses and cools to the temperature of the bomb. In nearly all industrial operations this water vapor escapes as steam in the flue gases and the latent heat of vaporization which it contains is not available for useful work. The net heat of combustion obtained by subtracting the latent heat from the gross calorific value is therefore an important figure in power plant calculations. If the percentage of hydrogen,  $H$ , in the sample is known, the net heat of combustion,  $H_n$  in Btu per pound can be calculated as follows:

$$H_n = 1.8H_g - 91.23H$$



## STANDARDIZING THE CALORIMETER

**The Energy Equivalent Factor.** The term “standardization” as used here denotes the operation of the calorimeter with a standard sample from which the energy equivalent or effective heat capacity for the system can be determined. The energy equivalent factor ( $W$ ) represents the energy required to raise the temperature of the calorimeter one degree, usually expressed as calories per degree Celsius. This factor for the 1341 calorimeter with an 1108 oxygen bomb will usually fall within a range from 2410 to 2430 calories per degree Celsius, with the exact value for each installation to be determined by the user. This requires a series of at least four standardization tests (and preferably more) from which an average can be taken to represent the true  $W$  value for the user’s calorimeter. This will provide a factor which can be used with confidence in subsequent tests with unknown materials. Standardization tests should always be repeated after changing any parts of the calorimeter, and occasionally as a check on both the calorimeter and the operating technique.

**Standard Samples.** A vial of 100 one-gram benzoic acid pellets is furnished with each calorimeter for standardization purposes. Additional benzoic acid pellets or powder can be obtained from Parr. For high precision measurements, a primary standard benzoic acid powder can be purchased from the National Bureau of Standards, Washington, D.C. The NBS also offers standard 2,2,4-trimethylpentane (Isooctane) as a calorific standard for testing volatile fuels. **Caution: Benzoic acid must always be compressed into a pellet before it is burned in an oxygen bomb** to avoid possible damage from rapid combustion of the loose powder. This is best accomplished by using a Parr 2811 Pellet Press. If a pellet press is not available, melt the powder into a lump by heating it carefully to the melting point, but do not overheat the powder as this will change the calorific value.

**Standardization Procedure.** The procedure for a standardization test is exactly the same as for testing a fuel sample. Use a pellet of calorific grade benzoic acid weighing not less than 0.9 nor more than 1.25 grams. Determine the corrected temperature rise,  $t$ , from the observed test data, also titrate the bomb washings to determine the nitric acid correction and measure the unburned fuse wire. Compute the energy equivalent by substituting in the following equation:

$$W = \frac{Hm + e_1 + e_3}{t}$$

- $W$  = energy equivalent of the calorimeter in calories per °C (Centigrade)
- $H$  = heat of combustion of the standard benzoic acid sample in calories per gram
- $m$  = mass of the standard benzoic acid sample in grams
- $t$  = net corrected temperature rise in °C
- $e_1$  = correction for heat of formation of nitric acid in calories
- $e_3$  = correction for heat of combustion of the firing wire in calories

**Example.** Standardization with a 1.1651 gram benzoic acid sample (6318 cal/ gm) produced a net corrected temperature rise of 3.047 °C. The acid titration required 11.9 ml of standard alkali and 8 cm of fuse wire were consumed in the firing. Substituting in the standardization equation:

$$\begin{aligned} H &= 6318 \text{ cal/ gram} \\ m &= 1.1651 \text{ gram} \\ e_1 &= (11.9 \text{ ml}) (1 \text{ cal/ ml}) = 11.9 \text{ cal} \\ e_3 &= (8 \text{ cm}) (2.3 \text{ cal/ cm}) = 18.4 \text{ cal} \\ t &= 3.047^\circ \text{ C} \\ W &= \frac{(6318)(1.1651) + 11.9 + 18.4}{3.047} \\ &= 2426 \text{ cal per } ^\circ \text{ C} \end{aligned}$$



## DISCUSSION OF CALCULATIONS

**Acid Correction.** Since combustion in the bomb takes place in an atmosphere of nearly pure oxygen at high temperature and pressure, several reactions take place which would not occur in burning the same material under normal atmospheric conditions. These side reactions are important because they generate an appreciable amount of heat which cannot be credited to the sample, and for which a correction must be made.

For example, in the normal combustion of coal, all sulfur is oxidized and liberated as  $\text{SO}_2$  but nitrogen in the material usually is not affected. Likewise, no change occurs in the nitrogen of the air required for normal combustion. But, when the same coal is burned in the oxygen bomb, oxidation of the sulfur is carried further to form  $\text{SO}_3$  which combines with water vapor to form  $\text{H}_2\text{SO}_4$ ; and some of the nitrogen in the bomb is also oxidized and combined with water vapor to form  $\text{HNO}_3$ . These two side reactions result in acids within the bomb, and require a correction to account for the heat liberated in their formation.

In computing the correction for acid formation it is assumed that all of the acid titrated is nitric acid ( $\text{HNO}_3$ ), and that the heat of formation of 0.1N  $\text{HNO}_3$  under bomb conditions is 14.1 Kcal per mol. Obviously, if sulfuric acid is also present, part of the correction for  $\text{H}_2\text{SO}_4$  is included in the nitric acid correction. The sulfur correction described below takes care of the difference between the heats of formation of nitric and sulfuric acids.

**Sulfur Correction.** A correction of 1.4 Kcal must be applied for each gram of sulfur converted to sulfuric acid. This is based upon the heat of formation of 0.17N  $\text{H}_2\text{SO}_4$  which is 72.2 Kcal per mol. But a correction of  $2 \times 14.1$  Kcal per mol of sulfur is included in the nitric acid correction. Therefore the additional correction which must be applied for sulfur will be  $72.2 - (2 \times 14.1)$  or 44.0 Kcal per mol, or 1.37 Kcal per gram of sulfur. For convenience, this is expressed as 13.7 calories for each percentage point of sulfur per gram of sample.

**Fuse Wire Correction.** The wire used as a fuse for igniting the sample is partly consumed in the combustion. Thus the fuse generates heat both by the resistance it offers to the electric firing current, and by the heat of combustion of that portion of the wire which is burned. It can be assumed that the heat input from the electric firing current will be the same when standardizing the calorimeter as when testing an unknown sample, and this small amount of energy therefore requires no correction. However, it will be found that the amount of wire consumed will vary from test to test, therefore a correction must be made to account for the heat of combustion of the metal.

The amount of wire taking part in the combustion is determined by subtracting the length of the recovered unburned portion from the original length of 10 cm. The correction is then computed for the burned portion by assuming a heat of combustion of 2.3 calories per cm. for Parr 45C10 (No. 34 B & S gage "Chromel C") wire, or 2.7 calories per cm for No. 34 B & S gage iron wire.

**Radiation Correction.** The method recommended for calculating the correction for heat gain or loss from a plain calorimeter is that specified by the American Society for Testing and Materials as published under ASTM Designations D240 and D3286. It is based upon the work of Dr. H.C. Dickinson at the National Bureau of Standards who showed that the amount of heat leak during a test could be approximated by assuming that the calorimeter is heated by its surroundings during the first 63 per cent of the temperature rise at a rate equal to that measured during the 5-minute preperiod. The method then assumes that the cooling (or heating) rate during the remaining 37 per cent of the rise is the same as the rate observed during the 5-minute postperiod. For most experimental work the dividing point between these two periods is taken as that point in time, b,



when the temperature has reached six-tenths (instead of 63%) of the total rise. Note that these two time intervals must be expressed in minutes and decimal fractions (Example: 1.4 min. and 6.6 min.).

**Magnitude of Errors.** The following examples illustrate the magnitude of errors which may result from faulty calorimeter operations. They are based upon an assumed test in which a 1.0000 gram sample produced a 2.800 °C temperature rise in a calorimeter having an energy equivalent of 2400 calories per ° C.

An error of 1 millimeter in making the acid titration will change the thermal value 1.0 cal.

An error of 1 centimeter in measuring the amount of fuse wire burned will change the thermal value 2.3 cal.

An error of 1 gram in measuring the 2 kilograms of water will change the thermal value 2.8 cal.

An error of 1 milligram in weighing the sample will change the thermal value 6.7 cal.

An error of 0.002 °C in measuring the temperature rise will change the thermal value 4.8 cal.

If all of these errors were in the same direction, the total error would be 17.6 cal.

## MAINTENANCE

**Calorimeter Maintenance.** The high polished chrome finish on the calorimeter bucket is needed to minimize heat transfer. If this finish becomes dull, the bucket should be replaced. Also check the bucket stirrer frequently to be sure that it turns freely. Any drag or friction in the stirrer will cause slow and erratic temperature response in the calorimeter. Add a few drops of machine oil annually to the small hole in the top of the stirrer assembly. Move the shaft of the assembly up and down to distribute the oil thoroughly.

**General Cleaning Instructions.** Wipe exterior surfaces with lightly dampened cloth containing mild soap solution.

### Fuse Ratings

The replacement of protective fuses should be performed by qualified personnel.

Ignition Unit 2901EB: Fast-acting, 1.5 Amps, 250 Vac (Parr number: 139E2)

Ignition Unit 2091EE: Fast-acting, 1.0 Amps, 250 Vac (Parr number: 139E6)

**Electric Ignition Problems.** If the indicator light does not come on when the firing button is pressed on the ignition unit there is either an open circuit in the system or a fault on the A1580E circuit board. An open circuit can usually be located with an ohmmeter. Flex the lead wires during any continuity check as the wires may be broken and making only intermittent contact. If the red indicator light glows during ignition but the bomb fuse does not burn, check the system for a voltage leak to ground, most likely in the insulated electrode on the bomb head. Check the electrode using the high impedance scale on an ohmmeter and replace the electrode insulator and seal if leakage is indicated.

If test methods for hazardous materials require the operator to stand away from the calorimeter when firing the bomb, move the ignition unit to a protected location and add longer wires to the calorimeter. Although remote firing is not necessary for most samples, the operator should always step back from the calorimeter when firing the bomb, and he should never bring his head over the calorimeter during the first 20 seconds after firing.

## 6772 CALORIMETRIC THERMOMETER

To improve the precision and simplify the procedure for measuring and recording the temperature rise in a 1341 Calorimeter, Parr offers the 6772 Calorimetric Thermometer. Readings are taken with a thermistor sealed in a stainless steel probe. This two-channel precision calorimetric thermometer features Parr's newest generation microprocessor control. The thermometer uses a Linux operating system with communication and file management systems comparable to a PC. A bright, color, touch screen display and data input system utilizes a graphical interface for easy instrument setup and operation. Three RS232 ports are available for use with a balance, printer, or barcode reader. (For more information on barcode capability, please contact Parr's sales staff.) An Ethernet port is available for data transfer using TCP/IP communications. No additional ignition source is required as the 6772 Calorimetric Thermometer acts as an ignition unit.

### Specifications:

- Thermistor Probe
- One Probe – Standard, Two Probes – Optional
- 0.0001 °C Temperature Resolution
- Absolute Accuracy:  
±0.1 °C (without calibration)  
±0.05 °C (with calibration)
- Repeatability:  
±0.002 °C (Single Point)
- Linearity:  
±0.002 °C (10 °C Span)
- FlashROM memory and network communications
- Balance & Printer Port: RS232C
- Updates via the Internet

Please refer to Parr Bulletin 6700 for complete details on the 6772 Calorimetric Thermometer.





### Electrical Hookup of 6772 Calorimetric Thermometer to 1341 Calorimeter

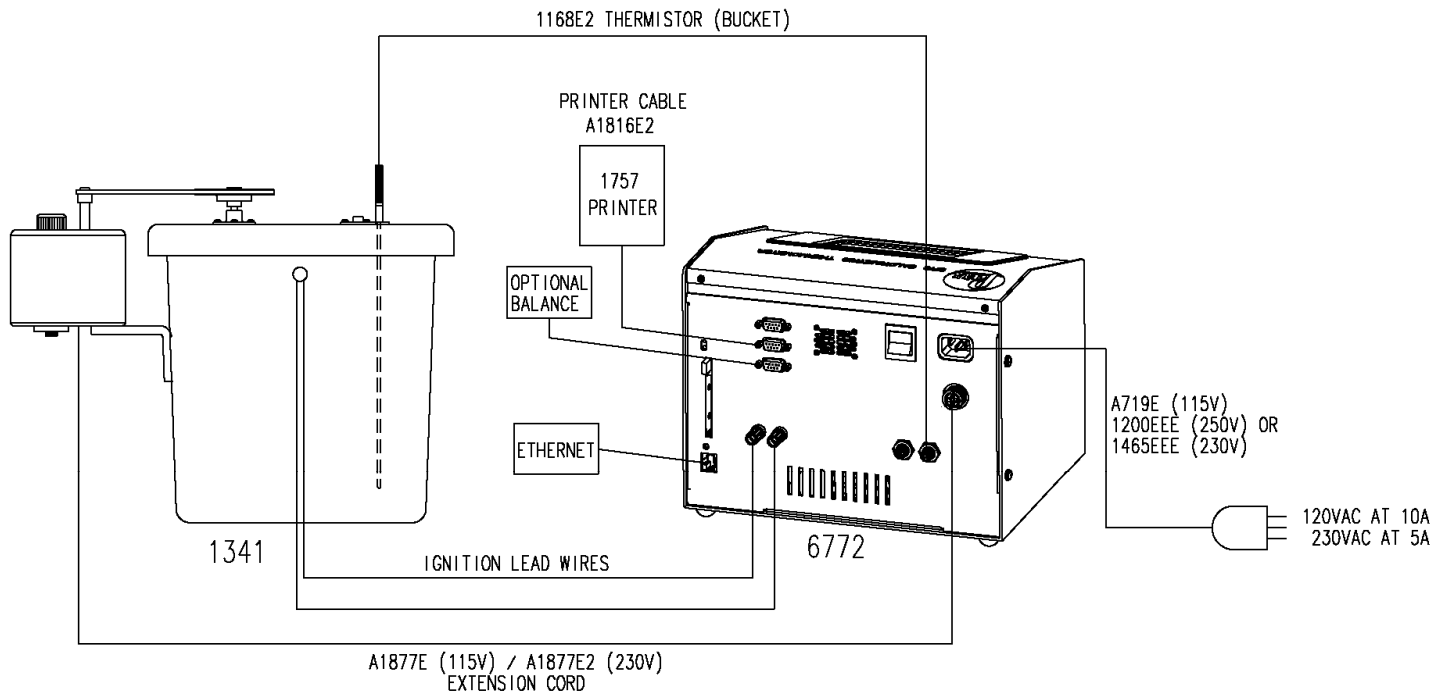

**PARTS FOR THE 1341 CALORIMETER**

Key No.	Part No.	Description
1	A50MEB	Motor Assembly with Pulley, 115V 60 Hz
	A50MEE	Motor Assembly with Pulley, 230V 50/60 Hz
2	36M4	Motor Pulley
3	37M2	Stirrer Drive Belt
4	37C2	Stirrer Pulley
5	A27A	Stirrer Bearing Assembly
6	A468E	Ignition Wire
7	A30A3	Stirrer Shaft with Impeller
8	A391DD	Oval Bucket
9	A1100DD	Calorimeter Jacket with Cover
10	1108	Oxygen Combustion Vessel
11	182VBAD	Male Connector
12	1168E2	Thermistor

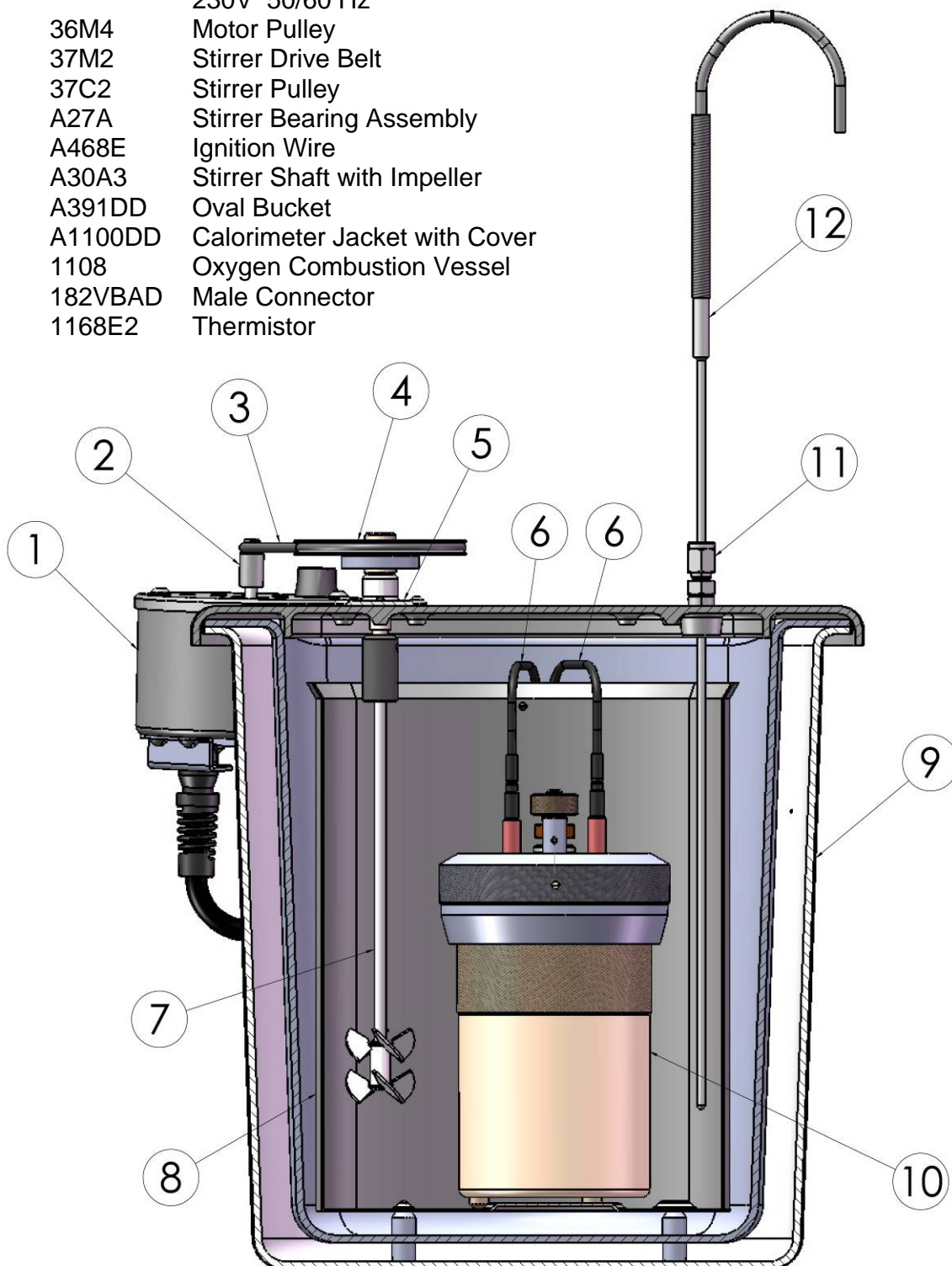



**PARR INSTRUMENT COMPANY**

**211 Fifty-Third Street**

Moline, Illinois 61265 USA

309/762-7716 800/872-7720

Fax 309/762-9453

<http://www.parrinst.com> • E-Mail: [parr@parrinst.com](mailto:parr@parrinst.com)